

RICOH

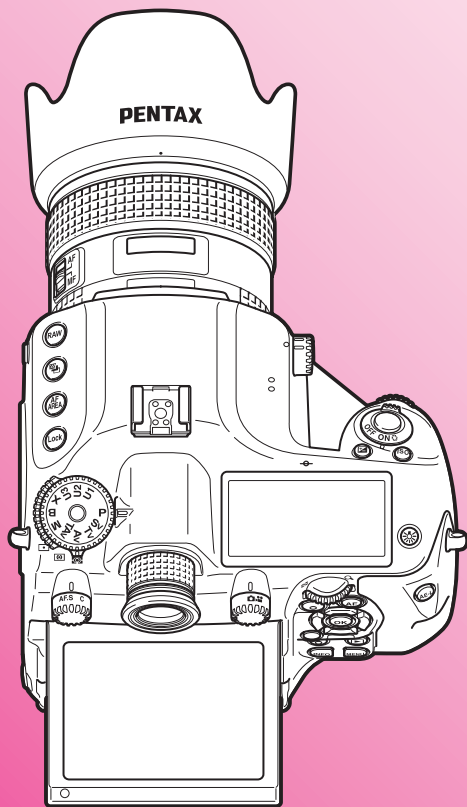

Medium Format Digital SLR Camera

PENTAX 645Z

Operating Manual



To ensure the best performance from your camera,
please read the Operating Manual before using the camera.

Thank you for purchasing our PENTAX 645Z medium format digital SLR camera. Please read this manual before using the camera in order to get the most out of all the features and functions. Keep this manual safe, as it can be a valuable tool in helping you to understand all the camera's capabilities.

Lenses you can use

In general, lenses that can be used with this camera are D FA645 and FA645 lenses, and 645 lenses that have an Aperture **A** (Auto) position. To use any other lens or accessory, see p.28 of this manual.

Regarding copyrights

Images taken with this camera that are for anything other than personal enjoyment cannot be used without permission according to the rights as specified in the Copyright Act. Please take care, as there are cases where limitations are placed on taking pictures even for personal enjoyment during demonstrations, performances or of items on display. Images taken with the purpose of obtaining copyrights also cannot be used outside the scope of use of the copyright as laid out in the Copyright Act, and care should be taken here also.

Trademarks

Microsoft, Windows and Windows Vista are registered trademarks of Microsoft Corporation in the United States of America and other countries. Macintosh, Mac OS, and QuickTime are trademarks of Apple Inc., registered in the U.S. and other countries.

Intel, Intel Core, and Pentium are trademarks of Intel Corporation in the U.S. and/or other countries.

SDXC Logo is a trademark of SD-3C, LLC.

Eye-Fi, the Eye-Fi logo and Eye-Fi *connected* are trademarks of Eye-Fi, Inc.

This product includes DNG technology under license by Adobe Systems Incorporated.

The DNG logo is either a registered trademark or trademark of Adobe Systems Incorporated in the United States and/or other countries.

HDMI, the HDMI logo and High-Definition Multimedia Interface are trademarks or registered trademarks of HDMI Licensing, LLC in the United States and/or other countries.

All other trademarks are the property of their respective owners.

This product supports PRINT Image Matching III. PRINT Image Matching enabled digital still cameras, printers and software help photographers to produce images more faithful to their intentions. Some functions are not available on printers that are not PRINT Image Matching III compliant.

Copyright 2001 Seiko Epson Corporation. All Rights Reserved. PRINT Image Matching is a trademark of Seiko Epson Corporation. The PRINT Image Matching logo is a trademark of Seiko Epson Corporation.

AVC Patent Portfolio License

This product is licensed under the AVC Patent Portfolio License for the personal use of a consumer or other uses in which it does not receive remuneration to (i) encode video in compliance with the AVC standard ("AVC video") and/or (ii) decode AVC video that was encoded by a consumer engaged in a personal activity and/or was obtained from a video provider licensed to provide AVC video. No license is granted or shall be implied for any other use.

Additional information may be obtained from MPEG LA, L.L.C. See <http://www.mpegla.com>.

To users of this camera

- Do not use or store this camera in the vicinity of equipment that generates strong electromagnetic radiation or magnetic fields. Strong static charges or the magnetic fields produced by equipment such as radio transmitters could interfere with the monitor, damage the stored data, or affect the camera's internal circuitry and cause camera misoperation.
- The liquid crystal panel used for the monitor is manufactured using extremely high precision technology. Although the level of functioning pixels is 99.99% or better, you should be aware that 0.01% or fewer of the pixels may not illuminate or may illuminate when they should not. However, this has no effect on the recorded image.
- In this manual, the generic term "computer(s)" refers to either a Windows PC or a Macintosh.
- In this manual, the term "battery(ies)" refers to any type of batteries used for this camera and its accessories.

There is a possibility that the illustrations and the display screen of the monitor in this manual are different from the actual ones.

FOR USING YOUR CAMERA SAFELY

We have paid close attention to the safety of this camera. When using this camera, we request your special attention regarding items marked with the following symbols.



Warning

This symbol indicates that ignoring this item could cause serious personal injuries.



Caution

This symbol indicates that ignoring this item could cause minor or medium personal injuries, or loss of property.

ABOUT THE CAMERA



Warning

- Do not disassemble or modify the camera. High voltage areas are present inside the camera, with the risk of electric shock.
- If the camera interior is exposed due to dropping or otherwise damaging the camera, never touch the exposed portion. There is a risk of electric shock.
- Do not aim the camera at the sun or other strong light sources when taking pictures or leave the camera sitting in direct sunlight with the lens cap off. Doing so may cause the camera to malfunction or cause a fire.
- Do not look at the sun or other strong light sources through the lens. Doing so may lead to a loss of eyesight or cause vision to be impaired.
- If any irregularities occur during use, such as smoke or a strange odor, stop use immediately, remove the battery or the AC adapter, and contact your nearest service center. Continued use can cause a fire or electrical shock.



Caution

- Some portions of the camera heat up during use. There is a risk of low temperature burns when holding such portions for long periods.
- Should the monitor be damaged, be careful of glass fragments. Also, be careful not to allow the liquid crystal to get on your skin or in your eyes or mouth.
- Depending on your individual factors or physical condition, the use of the camera may cause itching, rashes or blisters. In case of any abnormality, stop using the camera and get medical attention immediately.

About the Battery Charger and AC Adapter



Warning

- Always use the battery charger and AC adapter exclusively developed for this camera, with the specified power and voltage. Using a battery charger or AC adapter not exclusive to this camera, or using the exclusive battery charger or AC adapter with an unspecified power or voltage can cause a fire, electric shock, or camera breakdown. The specified voltage is 100 - 240V AC.
- Do not disassemble or modify the product. This can cause a fire or electrical shock.
- If the generation of smoke or strange odor from the product or other abnormality occurs, immediately discontinue using and consult your nearest service center. Continued use can cause a fire or electrical shock.
- If water should happen to get inside the product, consult your nearest service center. Continued use can cause a fire or electrical shock.

- If you see a lightning flash or hear thunder during use of the battery charger or AC adapter, unplug the power plug and discontinue using. Continued use can cause damage to the product, fire or electrical shock.
- Wipe off the power plug if it should become covered with dust. Accumulated dust may cause a fire.
- To reduce the risk of hazards, use only CSA/UL certified power supply cord set, cord is Type SPT-2 or heavier, minimum NO.18 AWG copper, one end with a molded-on male attachment plug cap (with a specified NEMA configuration), and the other is provided with a molded-on female connector body (with a specified IEC nonindustrial type configuration) or the equivalent.

 **Caution**

- Do not place or drop heavy objects on or forcefully bend the AC plug cord. Doing so may damage the cord. Should the AC plug cord be damaged, consult your nearest service center.
- Do not touch or short-circuit the terminal area of the AC plug cord while the cord is plugged in.
- Do not handle the power plug with wet hands. This can cause an electric shock.
- Do not drop the product, or subject it to violent impact. This can cause the product to breakdown.
- Do not use the battery charger D-BC90 to charge batteries other than the rechargeable lithium-ion battery D-LI90. Attempting to charge other types of batteries may cause an explosion or heating, or may damage the battery charger.

About the Battery

 **Warning**

- If any leakage from the battery should come in contact with your eyes, do not rub them. Flush your eyes with clean water and get medical attention immediately.

 **Caution**

- Only use the specified battery with this camera. Use of other batteries may cause an explosion or fire.
- Do not disassemble the battery. Disassembling the battery may cause an explosion or leakage.
- Remove the battery from the camera immediately if it becomes hot or begins to smoke. Be careful not to burn yourself during removal.
- Keep wires, hairpins, and other metal objects away from the + and - contacts of the battery.
- Do not short the battery or dispose of the battery in fire. This can cause an explosion or fire.
- If any leakage from the battery should come in contact with skin or clothing, it may cause irritation to the skin. Wash the affected areas thoroughly with water.
- Precautions for D-LI90 Battery Usage:
USE SPECIFIED CHARGER ONLY.
 - RISK OF FIRE AND BURNS.
 - DO NOT INCINERATE.
 - DO NOT DISASSEMBLE.
 - DO NOT SHORT CIRCUIT.
 - DO NOT EXPOSE TO HIGH TEMP. (140°F / 60°C)SEE MANUAL.

Keep the Camera and its Accessories out of the Reach of Small Children

Warning

- Do not place the camera and its accessories within the reach of small children.
 1. If the product falls or is operated accidentally, it may cause serious personal injuries.
 2. Wrapping the strap around a neck may cause suffocation.
 3. To avoid the risk of a small accessory such as the battery or memory cards from being swallowed by mistake, keep them out of the reach of small children. Seek medical attention immediately if an accessory is accidentally swallowed.

Care to be Taken During Handling

Before Using Your Camera

- When traveling, take the Worldwide Service Network listing that is included in the package. This will be useful if you experience problems abroad.
- When the camera has not been used for a long time, confirm that it is still working properly, particularly prior to taking important pictures (such as at a wedding or when traveling). Contents of the recording cannot be guaranteed if recording, playback or transferring your data to a computer, etc. is not possible due to a malfunction of your camera or recording media (memory cards), etc.

About the Battery and Charger

- To keep the battery in optimum condition, avoid storing it in a fully charged state or in high temperatures.
- If the battery is left inserted and the camera is not used for a long time, the battery will over-discharge and shorten the battery's life.
- Charging the battery a day before use or on the day of use is recommended.
- The AC plug cord provided with this camera is developed exclusively for the battery charger D-BC90. Do not use it with other devices.

Precautions on Carrying and Using Your Camera

- Do not subject the camera to high temperatures or high humidity. Do not leave the camera in a vehicle, as the temperature can get very high.
- Do not subject the camera to strong vibrations, shocks, or pressure. Use a cushion to protect the camera from vibrations of motorcycles, automobiles, or ships.
- The temperature range for camera use is -10°C to 40°C (14°F to 104°F).
- The monitor may appear black at high temperatures, but will return to normal at normal temperatures.
- The monitor may respond more slowly at low temperatures. This is due to liquid crystal properties, and is not a malfunction.
- Sudden temperature changes will cause condensation on the inside and outside of the camera. Place the camera in your bag or a plastic bag, and remove it after temperatures of the camera and surroundings are equalized.

- Avoid contact with garbage, mud, sand, dust, water, toxic gases, or salt. These could cause the camera to breakdown. Wipe the camera to dry off any rain or water drops.
- Do not press on the monitor with excessive force. This could cause it to break or malfunction.
- Be careful not to overtighten the screw in the tripod socket when using a tripod.

Cleaning Your Camera

- Do not clean the camera with organic solvents such as thinner, alcohol, and benzine.
- Use a lens brush to remove dust accumulated on the lens. Never use a spray blower for cleaning as it may damage the lens.
- Please contact your nearest service center for professional cleaning of the CMOS sensor. (This will involve a fee.)
- Periodic inspections are recommended every one to two years to maintain high performance.

Storing Your Camera

- Do not store the camera with preservatives or chemicals. Storage in high temperatures and high humidity can cause mold to grow on the camera. Remove the camera from its case and store it in a dry and well-ventilated place.
- Avoid using or storing the camera where it may be exposed to static electricity or electrical interference.
- Avoid using or storing the camera in direct sunlight or in locations where it may be exposed to rapid changes in temperature or to condensation.

About SD Memory Cards

- The SD Memory Card is equipped with a write-protect switch. Setting the switch to LOCK prevents new data from being recorded on the card, the stored data from being deleted, and the card from being formatted by the camera or computer.

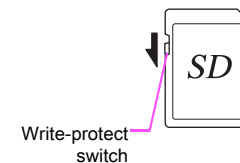

- The SD Memory Card may be hot when removing the card immediately after using the camera.
- Do not remove the SD Memory Card or turn off the power while the card is being accessed. This may cause the data to be lost or the card to be damaged.
- Do not bend the SD Memory Card or subject it to violent impact. Keep it away from water and store away from high temperatures.
- Do not remove the SD Memory Card while formatting. The card may be damaged and become unusable.
- Data on the SD Memory Card may be deleted in the following circumstances. We do not accept any liability for data that is deleted if
 1. the SD Memory Card is mishandled by the user.
 2. the SD Memory Card is exposed to static electricity or electrical interference.
 3. the SD Memory Card has not been used for a long time.
 4. the SD Memory Card or the battery is removed while the card is being accessed.
- If the SD Memory Card is not used for a long time, the data on the card may become unreadable. Be sure to regularly make a backup of important data on a computer.
- Format new SD Memory Cards. Also format SD Memory Cards previously used with other cameras.

- Please note that deleting data stored on an SD Memory Card, or formatting an SD Memory Card does not completely erase the original data. Deleted data can sometimes be recovered using commercially available software. If you are going to discard, give away or sell your SD Memory Card, you should ensure that the data on the card is completely deleted or the card itself is destroyed if it contains any personal or sensitive information.
- The data on your SD Memory Card should be managed at your own risk.

About Eye-Fi Cards

- An SD Memory Card with a built-in wireless LAN (“Eye-Fi card”) can be used with this camera.
- Use of an access point and an Internet connection are required for transferring images via wireless LAN. For details, refer to the Eye-Fi website. (<http://www.eye.fi>)
- Update your Eye-Fi card to the latest firmware before using it.
- Set [Action Mode] of [Wireless Memory Card] to [OFF], or do not use an Eye-Fi card in a location where the use of wireless LAN devices is restricted or prohibited, such as airplanes.
- Eye-Fi cards can be used only in the country in which the card was purchased. Please observe all local laws governing the Eye-Fi card usage.
- This camera features a function to enable/disable the communication function of the Eye-Fi card, however, we do not guarantee the operability of all Eye-Fi card functions.
- Refer to the Eye-Fi card manual for details on how to use the card.
- Please contact the Eye-Fi card manufacturer regarding any malfunctions or problems concerning Eye-Fi cards.

Provided Manuals

This camera comes with two manuals: “Operating Manual” (this book) and “Menu Reference”. Use these as needed.

Operating Manual

Describes the necessary preparations before use and the basic operations of your camera. The “Operating Manual” contains pages 1 to 107.

Menu Reference

Describes the functions that can be set when **MENU** is pressed and the product specifications. After you read the “Operating Manual” and become familiar with the basic operations of your camera, you can carry the “Menu Reference” with you as a handy reference guide. The “Menu Reference” contains pages R1 to R57.

The following symbols indicate reference page numbers with related information.

 Refer to another location within the same document.

 Refer to a location in the other document.

Operating Manual Contents

FOR USING YOUR CAMERA SAFELY	1
Care to be Taken During Handling	3
Provided Manuals	5
1 Before Using Your Camera	9
Checking the Contents of the Package	10
Names and Functions of Working Parts	11
Operating Controls	12
Adjusting the Angle of the Monitor	14
Display Indicators	15
Monitor	15
Viewfinder	22
LCD Panel	23
Electronic Level	23
2 Getting Started	25
Attaching the Strap	26
Attaching a Lens	26
Lens Compatibility Chart	28
Using the Battery and Charger	30
Charging the Battery	30
Inserting/Removing the Battery	30
Using the AC Adapter	32
Inserting a Memory Card	33
Power	34
Initial Settings	34
Language Setting	34
Date Adjustment	35
Formatting a Memory Card	36

Diopter Adjustment	37
Attaching the Large Eyecup	37
Testing Your Camera	38
Shooting	38
Reviewing Images	39
How to Change Function Settings	40
Using the Direct Keys	41
Using the Control Panel	41
Using the Menus	42

3 Shooting Functions

Focusing	44
Selecting the Focus Mode	44
Exposure Setting	47
Selecting the Metering Mode	47
Setting the Sensitivity	47
Changing the Exposure Mode	48
AE Lock	50
Movie Recording	51
Playing Back Movies	52
White Balance	53
Manual White Balance	54
Color Temperature	55
Drive Mode	56
Continuous Shooting	56
Self-timer	57
Remote Control	57
Multi-exposure	58
Interval Shooting	59
Interval Composite	60
Interval Movie Record	61
Exposure Bracketing	62
Mirror Lock-up Shooting	63

Flash Mode	64
Attaching a Flash	64
Setting the Flash Mode	65
Flash Compatibility Chart	66
Preview	67
Setting the Preview Method	67
Custom Image	68
Saving the Settings of a Captured Image	69

4 Playback and Processing Functions

71

Setting the Playback Functions	72
Displaying a Single Image	73
Deleting Images One by One	73
Zoom Display	73
Changing the Playback Method	74
Multi-image Display	74
Folder Display	75
Calendar Filmstrip Display	75
Slideshow	76
Image Rotation	76
Editing and Processing Images	77
Image Copy	77
Resize/Cropping	77
Color Moiré Correction	78
Digital Filter	79
Movie Edit	81
RAW Development	82
Protecting Images	83
Connecting the Camera to an AV Device	84

5 Using a Computer

85

Connecting to a Computer	86
System Requirements	86
Connecting the Camera to a Computer	87
Using the Provided Software	88
Installing the Software	88
Digital Camera Utility 5 Screen	90

6 Appendix

93

Optional Accessories	94
Error Messages	97
Troubleshooting	98
Index	100
WARRANTY POLICY	105

Regarding User Registration

In order to better serve you, we request that you complete the user registration, which can be found on the CD-ROM supplied with the camera (p.91) or on our website.

Thank you for your cooperation.

1

Before Using Your Camera

Checking the Contents of the Package	10
Names and Functions of Working Parts	11
Display Indicators	15

Checking the Contents of the Package

The following accessories are packaged with this camera.
Check that all accessories are included before using your camera.

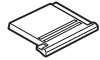

Hot shoe cover Fk
(Installed on camera)



Sync socket 2P cap
(Installed on camera)



Standard eyecup
(Installed on camera)



Large eyecup 645
O-EC107

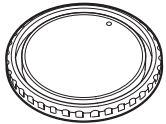

Body mount cap 645
(Installed on camera)



Triangular ring and protective cover
(Installed on camera)

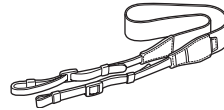

Strap
O-ST150



Rechargeable Lithium-ion Battery
D-LI90

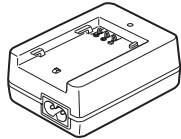

Battery charger
D-BC90



AC plug cord

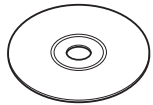

Software (CD-ROM)
S-SW150



Operating Manual
(this manual)



Menu Reference

Names and Functions of Working Parts

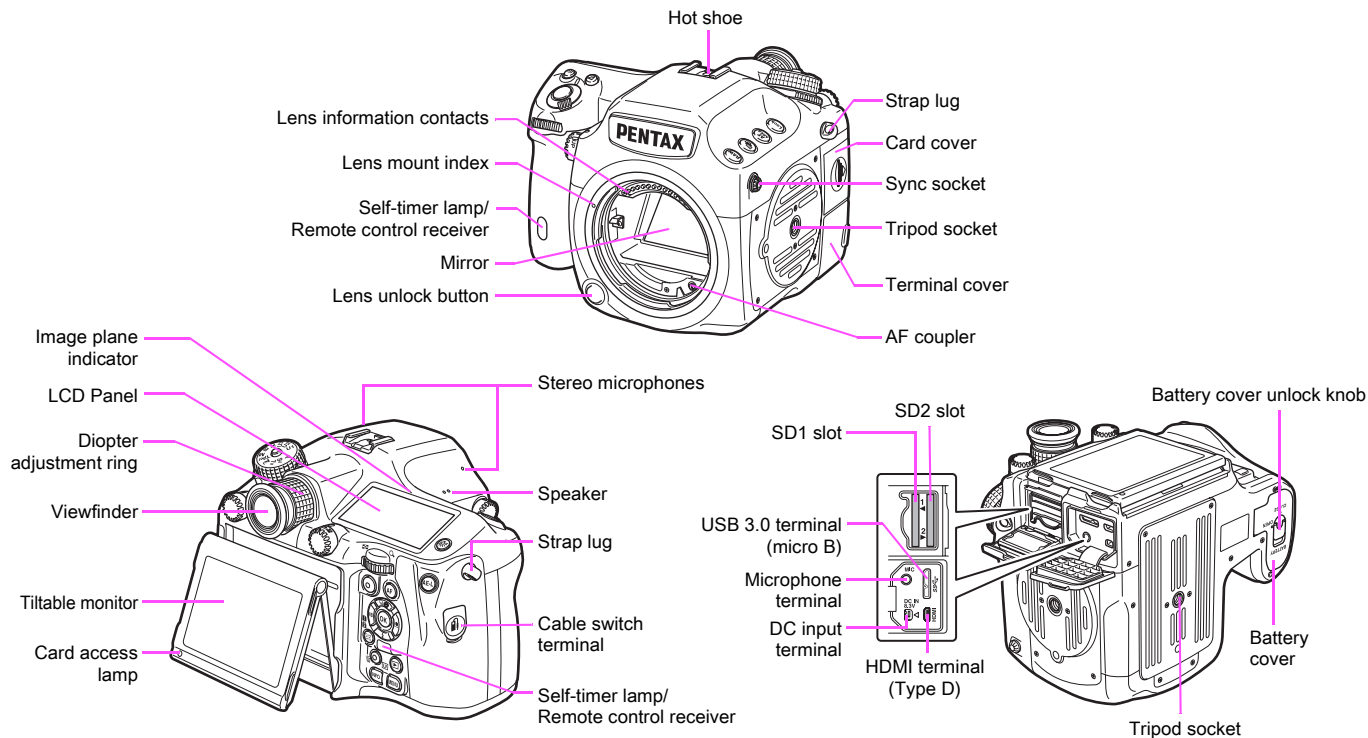

* The front and rear views show the camera with the Hot shoe cover Fk removed.

Caution

- Although the angle of the tiltable monitor can be changed (raised or lowered), the monitor cannot be moved in the left/right direction. Do not twist or apply strong force to the movable section, or hit the viewfinder part with the monitor. Always return to its original position when not in use.
- Be sure to close the terminal cover correctly to keep out dust and moisture.

Operating Controls

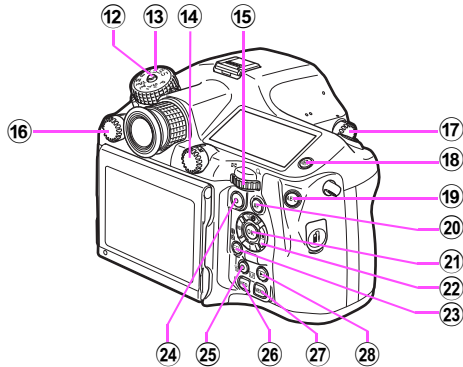
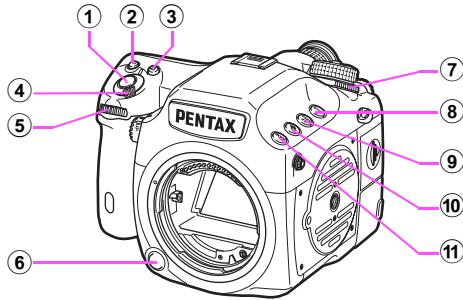

① Shutter release button

Press to capture images. (p.38)

In playback mode, press halfway to switch to capture mode.

② ISO button (ISO)

Press to change the ISO sensitivity. (p.47)

③ EV Compensation button (EV)

Press to change the exposure compensation value. (p.50)

④ Main switch

Move to turn the power on/off or to preview. (p.34, p.67)

⑤ Front e-dial (e)

Changes the values for camera settings such as exposure. (p.49)

You can change the menu category when a menu screen is displayed. (p.42)

In playback mode, use this to select a different image. (p.39)

⑥ Lens unlock button

Press to detach the lens on the camera. (p.26)

⑦ Metering mode switching dial

Changes the metering mode. (p.47)

⑧ Lock button (Lock)

Temporarily disables e-dial and button operations to prevent misoperation. (p.43)

⑨ AF area button (AF AREA)

Press to change the AF point. (p.45)

⑩ Exposure Bracketing button (BKT)

Sets exposure bracketing. (p.62)

⑪ RAW/Fx button (RAW)

You can assign a function to this button. (p.20)



⑫ Mode dial lock button









Press to allow the mode dial to be turned. (p.49)

⑬ Mode dial





Changes the exposure mode. (p.49)

⑭ Stills/Movie switching dial

Switches between  (Still capture) mode and  (Movie recording) mode. (p.38)

- 15 Rear e-dial** 
Changes the values for camera settings such as exposure. (p.49)
You can change the menu tabs when a menu screen is displayed. (p.42)
You can change the camera settings when the control panel is displayed. (p.41)
In playback mode, use this to magnify an image or display multiple images at the same time. (p.73, p.74)
- 16 AF mode switching dial**
Switches between the autofocus modes (**AFS/C**). (p.44)
- 17 Mirror Up dial**
Enables shooting with the mirror raised up. (p.63)
- 18 Illumination button** 
Illuminates the LCD panel. (p.23)
- 19 AE Lock button** (**AE-L**)
Locks the exposure value before shooting. (p.50)
In playback mode, the JPEG image that was just taken is also saved in RAW format. (p.39)
- 20 AF button** (**AF**)
Available for adjusting focus, instead of pressing the shutter release button halfway. (p.44)
- 21 OK button** (**OK**)
When a menu or the control panel is displayed, press this button to confirm the selected item.
- 22 Four-way controller** (**▲▼◀▶**)
Displays the Drive Mode, Flash Mode, White Balance or Custom Image setup menu. (p.41)
When a menu or the control panel is displayed, use this to move the cursor or change the item to set.
Press **▼** in single image display of the playback mode to display the playback mode palette. (p.72)
When selecting the area of an image to magnify or to use as a focusing area, you can move the area diagonally by pressing two keys at the same time.
- 23 AF point change/Card slot switching button** ( / )
Press this button to enable changing the AF point. (p.45)
In playback mode, press this button to switch between the memory cards for playback that are inserted in the two slots, SD1 and SD2. (p.39)
- 24 Green button** (**○**)
Resets the values being adjusted.
Switches to ISO AUTO when adjusting the sensitivity. (p.47)
- 25 Live View/REC/Delete button** ( /  / )
Displays the Live View image. (p.39)
Starts/stops recording a movie in  mode. (p.51)
In playback mode, press to delete images. (p.73)
- 26 INFO button** (**INFO**)
Changes the style of the display on the monitor. (p.15, p.19)
- 27 MENU button** (**MENU**)
Displays a menu. Press this button while the menu is displayed to return to the previous screen. (p.42)
- 28 Playback button** ()
Switches to playback mode. Press the button again to switch to capture mode. (p.39)

Button and Dial Operations

You can operate both a button and e-dial, such as  and  or  and , to change the settings using either of the following methods.

Operation	Confirming the Setting
Turn the dial while pressing the button.	Take your finger off the button.
Press the button, take your finger off the button, and then turn the dial.	Press the button again or wait until the exposure metering timer goes off.

Hereafter, this Operating Manual explains by using the “Turn the dial while pressing the button” operation.

For the **Lock** and **AF AREA** buttons, only the operation of turning  while pressing the button is available.

Adjusting the Angle of the Monitor

- 1 Hold the camera grip with your right hand and hold the top of the monitor with your left hand.

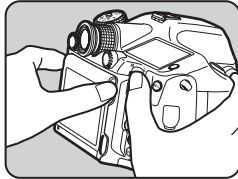

- 2 Slowly lower until it stops.

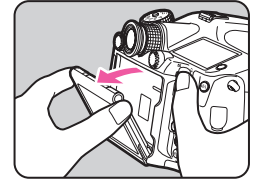

- 3 Hold the bottom of the monitor and lift upward.

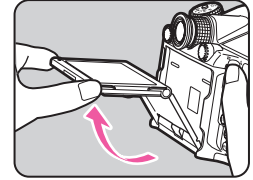

- 4 Adjust the angle.

Perform Step 3 and then Step 2 to retract the monitor.

Caution

- Do not twist or apply strong force to the movable section.
- Be careful not to hit the viewfinder part with the monitor.

Display Indicators

Monitor

The various indicators appear on the monitor depending on the camera settings and shooting conditions.

Capture Mode

With this camera, you can take pictures while looking through the viewfinder or while viewing the image on the monitor. When using the viewfinder, you can take pictures while checking the status screen displayed on the monitor and the viewfinder. When not using the viewfinder, you can take pictures while viewing the Live View image displayed on the monitor.

The camera is in “standby mode” when it is ready to shoot, such as when the status screen or Live View image is displayed. Press **INFO** in standby mode to display the “control panel” and change settings. (p.17) You can change the type of information displayed in standby mode by pressing **INFO** while the control panel is displayed. (p.18)

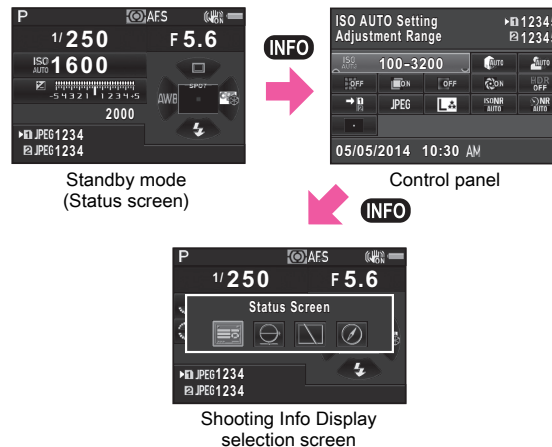

Status Screen

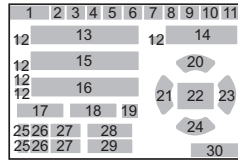

- | | |
|---|---|
| <ol style="list-style-type: none"> 1 Exposure Mode (p.48) 2 AE Lock (p.50) 3 Mirror Up (p.63) 4 Copyright Information embedded (📄 p.R33) 5 HDR Capture (📄 p.R16) 6 Metering mode (p.47) 7 Focus Method (p.44) 8 Wireless LAN status (📄 p.R34) 9 GPS positioning status (📄 p.R18) 10 Shake Reduction (p.63) 11 Battery level (p.31) 12 E-dial guide 13 Shutter speed 14 Aperture value 15 Sensitivity (p.47) 16 EV Compensation (p.50)/ Exposure Bracketing (p.62) | <ol style="list-style-type: none"> 17 Enable/Disable Controls (📄 p.R43) 18 Number of shots during Multi-exposure, Interval Shooting or Interval Composite 19 180° Rotation Info (📄 p.R15) 20 Drive Mode (p.56) 21 White Balance (p.53) 22 AF point (p.45) 23 Custom Image (p.68) 24 Flash Mode (p.65) 25 Card slot number 26 File Format (📄 p.R15) 27 Image storage capacity 28 Flash Exposure Compensation (p.65) 29 White Balance fine tuning (p.53) 30 Operation guide |
|---|---|

Live View

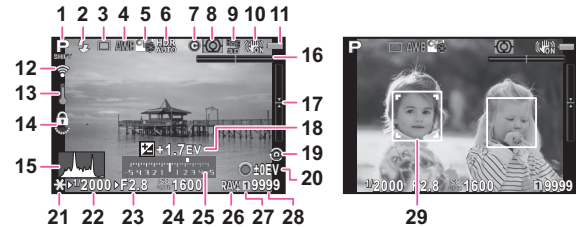

- | | |
|--|--|
| <ol style="list-style-type: none"> 1 Exposure Mode (p.48) 2 Flash Mode (p.65) 3 Drive Mode (p.56) 4 White Balance (p.53) 5 Custom Image (p.68) 6 HDR Capture (📄 p.R16) 7 Copyright Information embedded (📄 p.R33) 8 Metering mode (p.47) 9 GPS positioning status (📄 p.R18) 10 Shake Reduction (p.63)/ Movie SR (📄 p.R25) 11 Battery level (p.31) 12 Wireless LAN status (📄 p.R34) 13 Temperature warning 14 Enable/Disable Controls (📄 p.R43) 15 Histogram 16 Electronic Level (horizontal tilt) (p.23) | <ol style="list-style-type: none"> 17 Electronic Level (vertical tilt) (p.23) 18 EV Compensation (p.50) 19 180° Rotation Info (📄 p.R15) 20 Operation guide
Number of shots during Multi-exposure, Interval Shooting or Interval Composite 21 AE Lock (p.50) 22 Shutter speed 23 Aperture value 24 Sensitivity (p.47) 25 EV bar scale 26 File Format (📄 p.R15) 27 Card slot number in use 28 Image storage capacity 29 Face detection frame (when [Contrast AF] is set to [Face Detection]) (p.46) |
|--|--|

Memo

- In [Live View] of the  menu, you can change the settings of the items displayed on the monitor during Live View. (📄 p.R19)

Control panel

📷 mode

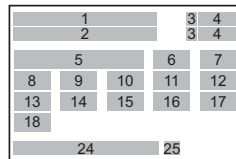
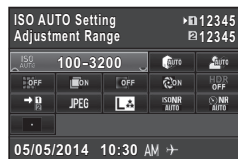

When shooting with Live View

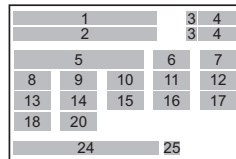
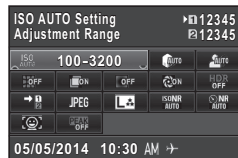

👤 mode

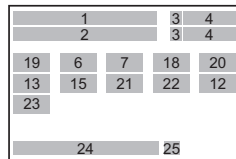
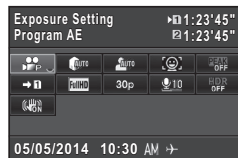

- 1 Function name
- 2 Setting
- 3 Card slot number
- 4 Number of recordable still pictures/movie recordable time
- 5 Sensitivity (p.47)/ ISO AUTO Setting (📖 p.R17)
- 6 Highlight Correction (📖 p.R16)
- 7 Shadow Correction (📖 p.R16)
- 8 Distortion Correction (📖 p.R16)
- 9 Lateral Chromatic Aberration Adjustment (📖 p.R16)
- 10 Peripheral Illumination Correction (📖 p.R16)
- 11 Diffraction Correction (📖 p.R16)
- 12 HDR Capture (📖 p.R16)
- 13 Memory Card Options (📖 p.R15)
- 14 File Format (📖 p.R15)
- 15 JPEG Recorded Pixels and Quality Level (📖 p.R15)/ movie recorded pixels (📖 p.R24)
- 16 High-ISO NR (📖 p.R17)
- 17 Slow Shutter Speed NR (📖 p.R17)
- 18 AF Active Area (p.45)/ Contrast AF (📖 p.R18)
- 19 Exposure Setting (📖 p.R24)
- 20 Focus Peaking (📖 p.R18)
- 21 Framerate (📖 p.R24)
- 22 Recording Sound Level (📖 p.R24)
- 23 Movie SR (📖 p.R25)
- 24 Current date and time
- 25 Destination (📖 p.R28)

📌 Memo

- Items that can be selected vary depending on the current camera setup.
- If no operations are made within 1 minute while the control panel is displayed, the camera will return to standby mode.
- You can change the display color of the status screen, control panel and menu cursor in [Display Color] of [LCD Display] in the 📖1 menu. (📖 p.R30)

Shooting Info Display

You can change the type of information displayed in standby mode by pressing **INFO** while the control panel is displayed. Use **◀▶** to select the type and press **OK**.

● When shooting with the viewfinder

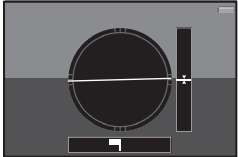
Status Screen	Displays the settings for shooting with the viewfinder. (p.16)	
Electronic Level	<p>Displays the camera angle. A bar scale indicating the camera angle in the horizontal direction appears at the bottom of the screen, and a bar scale indicating the camera angle in the vertical direction appears on the right side. If the camera angle cannot be detected, both ends and the center of the bar scales flash red. Disappears if no operations are made within 1 minute.</p>	 <p>Example: Tilted 1.5° to the left (yellow) No vertical tilt (green)</p>
Display Off	Nothing is displayed on the monitor.	
Electronic Compass	The current latitude, longitude, altitude, direction, and Coordinated Universal Time (UTC) are displayed. Turn the camera off and on again to return to the status screen. Available only when the optional GPS unit is attached to the camera and is operating. (p.96)	

● When shooting with Live View

Standard Information Display	The Live View image and the settings for shooting with Live View are displayed. (p.16)
No Information Display	Certain icons, such as those for the Exposure Mode and Drive Mode, are not displayed.

Vertical Display

When the camera is held vertically, the status screen and control panel are displayed in the vertical position. To not display images in the vertical position, set [Auto Screen Rotation] to off in [LCD Display] of the **1** menu. (p.R30)



Playback Mode

The captured image and shooting information are displayed in single image display of the playback mode. Press **INFO** to change the type of information displayed in single image display. Use **◀▶** to select the type and press **OK**.



Single image display
(Standard Information Display)

INFO

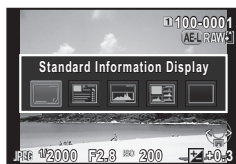

Playback Info Display
selection screen

Standard Information Display	Captured image, file format, exposure parameters, and operation guide indicators are displayed.
Detailed Information Display	Detailed information on how and when the image was taken is displayed (p.20).
Histogram Display	Captured image and brightness histogram are displayed (p.21). Not available during movie playback.
RGB Histogram Display	Captured image and RGB histogram are displayed (p.21). Not available during movie playback.
No Information Display	Only the captured image is displayed.

Memo

- Press **LR2** to switch between the memory cards inserted in the two slots, SD1 and SD2.
- The display selected in the Playback Info Display selection screen appears in playback mode when the camera is turned off and on again. If [Playback Info Display] is set to off in [Memory] of the **4** menu, the [Standard Information Display] always appears first when the camera is turned on. (p.R22)
- You can display the grid with [Grid Display] of the **1** menu. (p.R26)
- You can set the camera so that the bright (overexposed) areas in the image blink red with [Highlight Alert] of the **1** menu. (p.R26)

Detailed Information Display

Still pictures

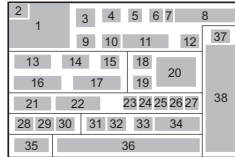

Movies

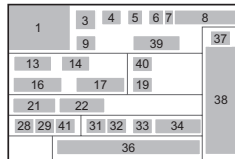

Page 2

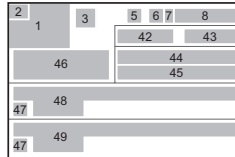
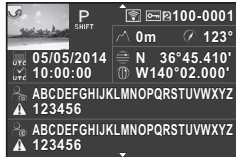

- 1 Captured image
- 2 Rotation Information (📷 p.R41)
- 3 Exposure Mode (p.48)
- 4 Digital Filter (p.79)/
HDR Capture (📷 p.R16)
- 5 Transferred via Wireless LAN (📷 p.R34)
- 6 Protect setting (p.83)
- 7 Card slot number in use
- 8 Folder number-File number (📷 p.R31, 📷 p.R33)
- 9 Drive Mode (p.56)
- 10 Flash Mode (p.65)
- 11 Flash Exposure Compensation (p.65)
- 12 Color Moiré Correction (p.78)
- 13 Shutter speed
- 14 Aperture value
- 15 Exposure Bracketing (p.62)
- 16 Sensitivity (p.47)
- 17 EV Compensation (p.50)
- 18 Focus Method (p.44)
- 19 Metering mode (p.47)
- 20 AF point (p.45)
- 21 White Balance (p.53)
- 22 White Balance fine tuning (p.53)
- 23 Distortion Correction (📷 p.R16)
- 24 Lateral Chromatic Aberration Adjustment (📷 p.R16)
- 25 Peripheral Illumination Correction (📷 p.R16)
- 26 Diffraction Correction (📷 p.R16)
- 27 Color Fringe Correction (p.82)
- 28 File Format (📷 p.R15)
- 29 JPEG Recorded Pixels (📷 p.R15)/movie recorded pixels (📷 p.R24)
- 30 JPEG Quality (📷 p.R15)
- 31 Highlight Correction (📷 p.R16)
- 32 Shadow Correction (📷 p.R16)
- 33 Shake Reduction (p.63)/
Movie SR (📷 p.R25)
- 34 Lens focal length
- 35 Color Space (📷 p.R41)
- 36 Shooting date and time
- 37 Custom Image setting (p.68)
- 38 Custom Image parameters
- 39 Length of time of the recorded movie
- 40 Volume
- 41 Framerate (📷 p.R24)
- 42 Altitude (📷 p.R18)
- 43 Lens direction (📷 p.R18)
- 44 Latitude (📷 p.R18)
- 45 Longitude (📷 p.R18)
- 46 Universal Coordinated Time
- 47 Information tampering warning
- 48 Photographer (📷 p.R33)
- 49 Copyright Holder (📷 p.R33)

Histogram Display/RGB Histogram Display

Use ▲▼ to switch between the Histogram Display and RGB Histogram Display.

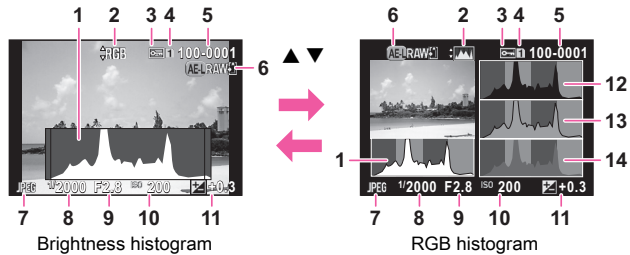

- 1 Histogram (Brightness)
- 2 Switch RGB histogram/
Brightness histogram
- 3 Protect setting
- 4 Card slot number in use
- 5 Folder number-File number
- 6 Save RAW Data (p.40)
- 7 File Format

- 8 Shutter speed
- 9 Aperture value
- 10 Sensitivity
- 11 EV Compensation
- 12 Histogram (R)
- 13 Histogram (G)
- 14 Histogram (B)

Viewfinder

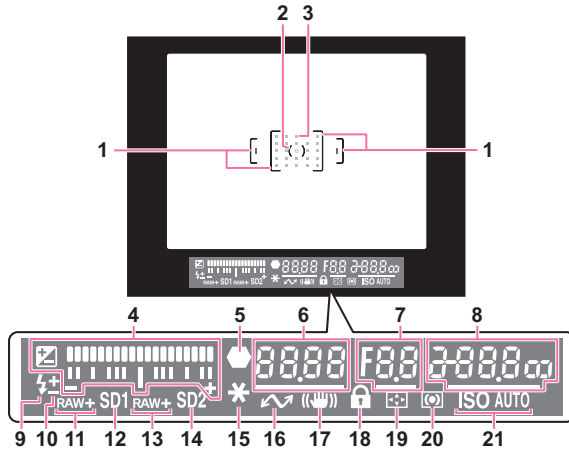

- 1 AF frame
- 2 Spot metering frame (p.47)
- 3 AF point (p.45)
- 4 EV bar scale:
Displays the exposure compensation value or the difference between the proper and current exposure values in **M** or **X** mode.
Displays the camera angle when [Electronic Level] is set to on.
- 5 Focus indicator
- 6 Shutter speed
- 7 Aperture value
- 8 Sensitivity (p.47):
Displays the difference between the proper and current exposure values in **M** or **X** mode when [Electronic Level] is set to on.
- 9 Flash:
Appears when the flash is available.
Blinks when the flash is recommended or is being charged.
- 10 Flash Exposure Compensation (p.65)
- 11 SD1 file format (📄 p.R15)

- 12 SD1 slot
- 13 SD2 file format (📄 p.R15)
- 14 SD2 slot
- 15 AE Lock (p.50)
- 16 Tethered shooting
- 17 Shake Reduction (p.63)
- 18 Enable/Disable Controls (📄 p.R43)
- 19 Change AF Point (p.45)
- 20 Metering mode (p.47)
- 21 ISO/ISO AUTO

● EV bar scale

Shows the difference between the proper and current exposure values in **M** or **X** mode. If the value exceeds the range of the EV bar scale, the “+” or “-” blinks.



● Exposure Warning

When the proper exposure cannot be obtained with the values set in **P**, **Sv**, **Tv**, **Av**, or **TAv** mode, the values beyond the range of automatic adjustment blink.

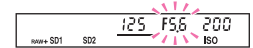

📌 Memo

- The AF point appears in red (Superimpose AF Area) when the shutter release button is pressed halfway. To turn off the red light of the superimposed AF point, set [14. Superimpose AF Area] to off in the **C2** menu. (📄 p.R40)
- The item 16 appears when the camera is connected to a computer using optional tethered shooting software.

LCD Panel

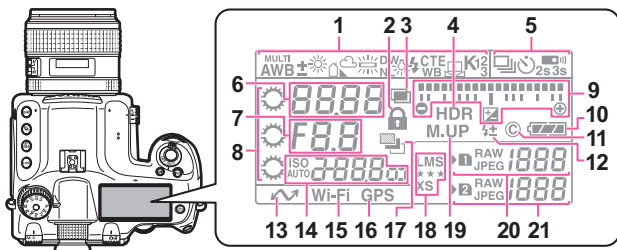

- | | |
|--|--|
| 1 White Balance (p.53) | 15 Wireless LAN connection (p.R34) |
| 2 Enable/Disable Controls (p.R43) | 16 GPS positioning status (p.R18) |
| 3 Multi-exposure (p.58) | 17 Exposure Bracketing (p.62) |
| 4 HDR Capture (p.R16) | 18 JPEG Recorded Pixels/JPEG Quality (p.R15) |
| 5 Drive Mode (p.56) | 19 Mirror Up (p.63) |
| 6 Shutter speed/Focusing area selection mode (p.45) | 20 SD1 file format (p.R15)/Remaining image storage capacity (up to [1999]) |
| 7 Aperture value | 21 SD2 file format (p.R15)/Remaining image storage capacity (up to [1999])/USB Connection mode (p.R30)/Sensor Cleaning (p.R37) |
| 8 E-dials | PcS: MSC mode |
| 9 EV bar scale/Electronic Level/EV Compensation (p.50) | PcP: PTP mode |
| 10 Battery level (p.31) | Cln: During sensor cleaning |
| 11 Copyright Information embedded (p.R33) | |
| 12 Flash Exposure Compensation (p.65) | |
| 13 Tethered shooting | |
| 14 Sensitivity (p.47)/Exposure compensation value (p.50) | |

Memo

- Press to illuminate the LCD panel. (p.R20)
- The item 13 appears when the camera is connected to a computer using optional tethered shooting software.

Electronic Level

You can check whether the camera is tilted horizontally by displaying the electronic level. The electronic level can be displayed on the EV bar scale in the viewfinder and LCD panel, and/or on the Live View screen.

Select whether to display the electronic level in [Electronic Level] of the 3 menu. (p.R19)

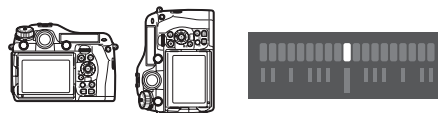

When level (at 0°)



When tilted 4.5° to the left



When held vertically and tilted 3° to the right

Memo

2

Getting Started

Attaching the Strap	26
Attaching a Lens	26
Using the Battery and Charger	30
Inserting a Memory Card	33
Power	34
Initial Settings	34
Diopter Adjustment	37
Testing Your Camera	38
How to Change Function Settings	40

Attaching the Strap

- 1 Pass the end of the strap through the triangular ring.

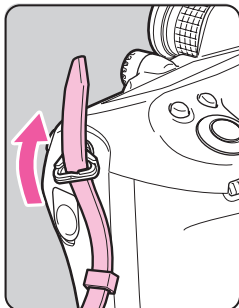

- 2 Secure the end of the strap on the inside of the clasp.

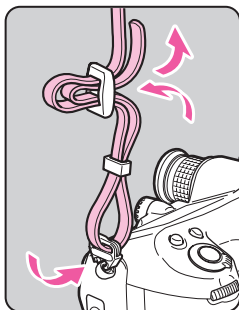

Attaching a Lens

- 1 Make sure that the camera is turned off.

- 2 Remove the body mount cap (1) and lens mount cap (2). Hold down the lens unlock button (3) and remove the body mount cap.

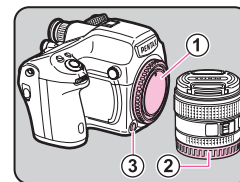

- 3 Align the lens mount index (red dots; 4) on the camera and the lens, and turn the lens clockwise.

Do not press the lens unlock button at this time.

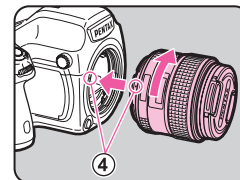

To remove the lens

Turn the lens counterclockwise while holding down the lens unlock button.

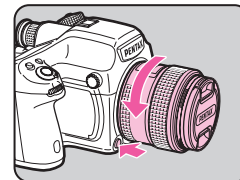

- 4** Remove the front lens cap by pushing the top and bottom portions as indicated in the illustration.

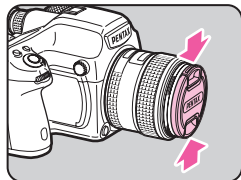

Caution

- When attaching or removing the lens, choose an environment that is relatively free of dirt and dust.
- Keep the body mount cap attached on the camera when a lens is not attached.
- Be sure to attach the lens mount cap and lens cap to the lens after removing it from the camera.
- Do not insert your fingers inside the lens mount of the camera or touch the mirror.
- The camera body and lens mount incorporate lens information contacts. Dirt, dust, or corrosion may damage the electrical system. Please contact your nearest service center for professional cleaning.
- We assume no responsibility nor liability for accidents, damages and malfunctions resulting from the use of lenses made by other manufacturers.

Lens Compatibility Chart

When using the D FA645 lens (for digital cameras), all of the functions of this camera are available. Lenses for our medium format film cameras can also be used with this camera; however, the following restrictions apply. (✓: Available #: Restricted ×: Not available)

	Lens	A645	FA645	A645/FA645	A645/FA645	67
Function	Accessories	Lens only		With Rear converter A and Auto extension tube A	With Helicoid extension tube *1	With Adapter 645 for 67 lens
P/Sv/Tv/TAv mode		✓	✓	✓	×	×
Av/M mode		✓	✓	✓	✓ *2	✓
Program P-TTL auto flash		✓	✓	✓	×	×
P-TTL auto flash		✓	✓	✓	✓	✓
Automatic change of lighting angle when using AF540FGZ, AF540FGZ II, AF500FTZ, AF360FGZ, AF360FGZ II, or AF330FTZ		×	✓	×	×	×
Display of aperture value in viewfinder at aperture position A		✓	✓	# *4	×	×
Display of aperture guide in viewfinder at a position other than A *3		×	✓	×	×	×
AF		×	✓	×	×	×
Display of focus indicator in viewfinder in MF mode *5		✓ *6	✓	✓	✓ *6	✓ *6
Metering mode switching		✓	✓	✓	# *7	# *7
[Lens Correction] of the  menu		×	✓	×	×	×

*1 This includes all types of helicoid extension tubes and accessories without information contacts.

*2 Stop-down metering

*3 Depending on the lens, the aperture ring value and the value displayed in the viewfinder may not match.

*4 The lens aperture value is displayed when using Auto extension tube A or Rear converter A645 2×.

The display varies when using Rear converter A645 1.4× with a lens other than A★645 300mm F4 or FA★645 300mm F4.

[Displaying the lens aperture value as is indicated on the lens]

FA645 300mm F5.6, FA645 400mm F5.6, A★645 600mm F5.6

[Displaying the maximum effective aperture value when combined with a lens]

A645 200mm F4, FA645 200mm F4, A★645 300mm F4, FA★645 300mm F4, A645 macro 120mm F4, FA645 macro 120mm F4



[Displaying the aperture value with the aperture stopped down by two stops]

FA645 150mm F2.8

*5 Available only when the lens aperture value without accessories is F5.6 or wider, or when the maximum effective aperture value combined with accessories is F5.6 or wider.

*6 When using A645 macro 120mm F4, the function may become unreliable when the magnification ratio on the lens is set to between "1" (1:1) and "2" (1:2).

 (Spot) is always selected as the focusing area selection mode.

*7 The camera uses  (Center-weighted metering) even when  (Multi-segment metering) is selected.

Using the Lens Shutter of the LS Lens

The PENTAX 645LS lenses have a built-in leaf shutter which allows for high speed flash synchronization.

When using a leaf shutter lens, set the shutter speed ring on the lens to LS.

Note that the following restrictions apply when using a leaf shutter lens.

- The shutter of the lens cannot be used during Live View.
- The camera operates in **M** mode regardless of the exposure mode setting on the camera.
 - The difference from the proper exposure is not displayed.
 - [LS] is displayed for the shutter speed.
 - The proper exposure is not obtained even when **○** is pressed.
- EV Compensation is not available.
 - Setting the shutter speed ring to LS when EV Compensation is set cancels EV Compensation.
- AE Lock is not available.
 - Setting the shutter speed ring to LS when AE Lock is set cancels AE Lock.
- Continuous Shooting, Self-timer (2 sec.), Remote Control (3 sec. delay), and Remote Continuous Shooting of the drive modes are not available.
 - Setting the shutter speed ring to LS when Self-timer (2 sec.) is set switches the shooting mode to Self-timer (12 sec.).
 - Setting the shutter speed ring to LS when Remote Control (3 sec. delay) or Remote Continuous Shooting is set switches the shooting mode to Remote Control (immediate release).
- Mirror Lock-Up Shooting is not available.
 - Setting the shutter speed ring to LS when the mirror is raised lowers the mirror.
- Optical Preview is not available.
 - If the shutter of the lens is charged in advance, Digital Preview can be used. (The same applies when using the Digital Preview to preview the image with White Balance or Custom Image.)

- Interval Shooting, Exposure Bracketing, and HDR Capture are not available.
 - Setting the shutter speed ring to LS when Exposure Bracketing or HDR Capture is set cancels the setting.
 - Setting the shutter speed ring to LS when Interval Shooting is set exits Interval Shooting.
- In Multi-exposure mode, the shutter of the lens must be charged manually for each shot.
- An external flash cannot be used even when connected to the hot shoe. Be sure to use the sync terminal on the lens.
- An external flash cannot be synchronized even when connected to the sync socket on the camera.
- The flash mode setting is not applied to LS shooting.

Using the Battery and Charger

Use the battery D-LI90 and battery charger D-BC90 exclusively developed for this camera.

Charging the Battery

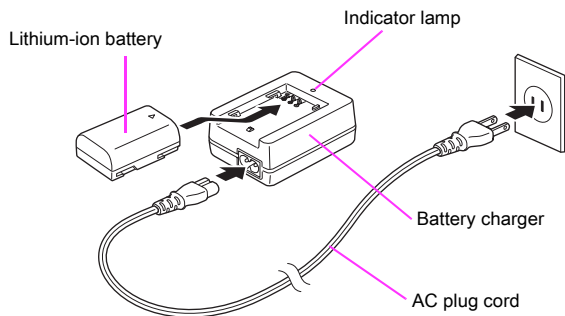

- 1** Connect the AC plug cord to the battery charger.
- 2** Plug the AC plug cord into the power outlet.
- 3** Face the ▲ mark on the battery up, and insert it into the battery charger.
The indicator lamp is lit while charging and turns off when the battery is fully charged.
- 4** Remove the battery from the battery charger.

Caution

- Do not use the battery charger D-BC90 to charge batteries other than D-LI90. Charging other batteries may cause damage or heating.
- Replace the battery with a new one in the following cases:
 - If the indicator lamp blinks or does not light after the battery is inserted correctly
 - If the battery starts to run down more quickly even after being charged (the battery may have reached the end of its service life)

Memo

- The maximum charging time is approximately 390 minutes (it depends on temperature and remaining battery power). Charge in a location where the temperature is between 0°C and 40°C.

Inserting/Removing the Battery

Caution

- Insert the battery correctly. If the battery is inserted incorrectly, it may not be removed.
- Wipe the electrodes of the battery with a soft dry cloth before inserting.
- Do not open the battery cover or remove the battery while the power is on.
- Be careful as the camera or battery may become hot after the camera is used continuously for a long period of time.
- Remove the battery when you will not use the camera for a long time. The battery may leak and damage the camera if left installed during prolonged periods of non-use. If the removed battery will not be used for six months or longer, charge the battery for about 30 minutes before storing it, and after that, recharge the battery every six to twelve months.
- Store the battery in a location where the temperature will remain at or below room temperature. Avoid locations with high temperatures.
- The date and time may be reset if you leave the battery out of the camera for long periods of time. If this happens, set the current date and time again. (📖 p.R28)

1 Open the battery cover.

Lift the battery cover unlock knob, turn it towards OPEN to unlock, and then pull the cover open.

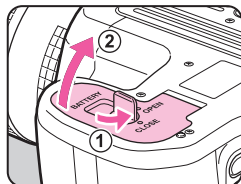

2 Face the ▲ mark on the battery towards outside of the camera, and insert the battery until it locks into place.

To remove the battery

Push the battery lock lever in the direction of ③.

Battery lock lever

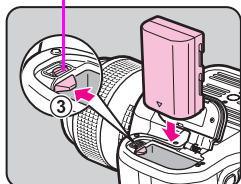

3 Close the battery cover.

Turn the battery cover unlock knob towards CLOSE to lock.

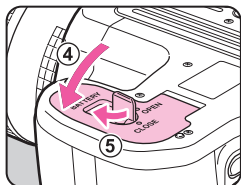

● Battery Level Indicator

You can check the remaining battery level with the battery level indicator on the monitor (when the monitor is in standby mode) or on the LCD panel.

Monitor	LCD Panel	Battery Level
(Green)		Battery is full.
(Green)		Battery is one-third empty.
(Yellow)		Battery is two-thirds empty.
(Red)		Battery is almost empty.
[Battery depleted]		The camera turns off after displaying the message. (The LCD panel indicator continues to blink.)

📌 Memo

- The battery level may not be displayed properly if the camera is used at low temperatures or when performing Continuous Shooting for a long time.
- Battery performance temporarily decreases as the temperature decreases. When using the camera in cold climates, have extra batteries at hand and keep them warm in your pocket. Battery performance will return to normal at room temperature.
- Have extra batteries ready when traveling overseas, or taking a lot of pictures.
- Use the optional AC adapter kit when using the camera for a prolonged period. (p.32)
- The battery level is not displayed when using the AC adapter.

Using the AC Adapter

We recommend using the optional AC adapter kit K-AC132 when using the monitor for a long time or when connecting to the camera to a computer or AV device.

1 Make sure that the camera is turned off, and open the terminal cover.

2 Align the ▲ marks on the DC terminal of the AC adapter and DC input terminal of the camera, and connect.

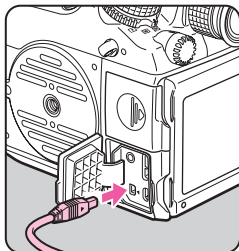

3 Connect the AC adapter to the AC plug cord, and plug the cord into the power outlet.

Caution

- Make sure that the camera is turned off before connecting or disconnecting the AC adapter.
- Make sure that connections are secure between the terminals. The memory card or data may be corrupted if the connection to the power supply is lost while the card is being accessed.
- The battery in the camera does not charge when connected to the AC adapter.
- Be sure to read the manual of the AC adapter kit before using the AC adapter.

Inserting a Memory Card

The following memory cards can be used with this camera.

- SD Memory Card, SDHC Memory Card, and SDXC Memory Card
- Eye-Fi card
- Flucard compatible with this camera

In this manual, these cards are referred to as memory cards. Ideally you should use a high-speed, large-capacity memory card.

⚠ Caution

- A memory card must be formatted with this camera before use. (👉 “Formatting a Memory Card” p.36)

1 Make sure that the camera is turned off.

2 Slide the card cover in the direction of ①.

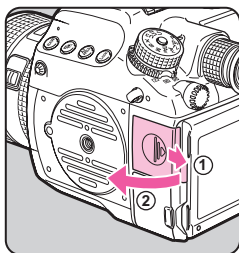

3 Insert the card all the way into the memory card slot with the memory card label facing toward the monitor.

Insert a memory card into one or both of the SD1 and SD2 slots.

To use an Eye-Fi card or a Flucard, insert the card in the SD2 slot.

To remove the memory card

Push the card in again.

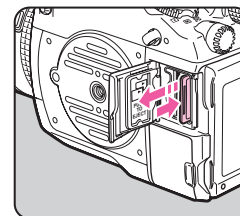
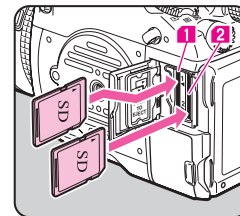

4 Close the card cover, and slide it in the opposite direction of ①.

⚠ Caution

- Be sure to fully close the card cover. The camera will not turn on if the card cover is open.
- Do not turn off the power or remove the memory card while the card access lamp is lit.
- Use a high-speed memory card when recording movies. If the write speed cannot keep up with the recording speed, the writing may stop during recording.

📌 Memo

- For details on how the data is recorded when two memory cards are inserted, refer to “Memory Card Options” (📖 p.R15).
- When using an Eye-Fi card or a Flucard, refer to “Wireless Memory Card” (📖 p.R34).



Power

1 Turn the main switch to [ON].

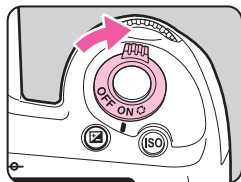
The first time the camera is turned on after purchase, the [Language/言語] screen appears.



Memo

- Always turn the camera off when not in use.
- The power will automatically turn off when you do not perform any operations within a set period of time (Auto Power Off). To reactivate the camera after it turns off automatically, turn it on again, or press the shutter release button or .
- By default, the camera is set to power off automatically after 1 minute of inactivity. You can change the setting in [Auto Power Off] of the  3 menu. ( p.R34)

Initial Settings

Language Setting

The first time the camera is turned on after purchase, the [Language/言語] screen appears on the monitor. Follow the procedure below to set the display language and the current date and time.

1 Use to select the desired language and press .

The [Initial Setting] screen appears in the selected language.



2 Press .

The cursor moves to  (Hometown).

If the hometown is set as you desire, proceed to Step 7 on p.35.

3 Press .

The [ Hometown] screen appears.

4 Use to select a city.

Use  to change the region.



5 Press .

The cursor moves to [DST] (daylight saving time).

6 Use ◀▶ to select or and press **OK.**

The camera returns to the [Initial Setting] screen.

7 Press ▼.

The cursor moves to [Text Size].

8 Press ▶, use ▲▼ to select [Standard] or [Large], and press **OK.**

Selecting [Large] increases the text size of the selected menu items.

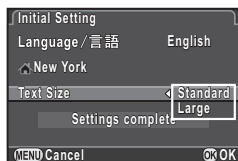
**9 Press ▼ to select [Settings complete] and press **OK**.**

The [Date Adjustment] screen appears.

**Memo**

- You can select from 75 cities for the hometown and destination. (p.R28)
- In this manual, the menu screens hereafter are shown with [Text Size] set to [Standard].
- To change the Language, Hometown or Text Size settings, use the ↶1 menu. (p.R28)

Date Adjustment**1 On the [Date Adjustment] screen, press ▶ and use ▲▼ to select the date format.**

Select [mm/dd/yy], [dd/mm/yy] or [yy/mm/dd].

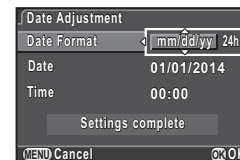
**2 Press ▶, and use ▲▼ to select 24h or 12h.****3 Press ▶.**

The frame returns to [Date Format].

4 Press ▼ and then ▶.

The frame moves to the month if the date format is set to [mm/dd/yy].

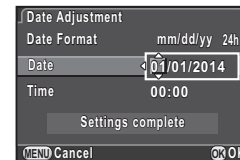
5 Use ▲▼ to set the month, day and year.**6 Set the time in the same manner.**

If you select [12h] in Step 2, the camera switches between am and pm depending on the time.

7 Select [Settings complete] and press **OK.**

The status screen is displayed and the camera switches to standby mode.

The seconds value is set to 0 seconds when **OK** is pressed.

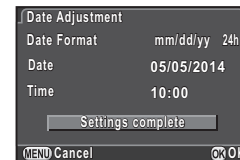

Memo

- Pressing **MENU** while setting the date and time cancels the settings and switches the camera to standby mode. The [Initial Setting] screen or the [Date Adjustment] screen will appear again the next time the power is turned on.
- To change the date and time, use the **1** menu. (📖 p.R28)

Formatting a Memory Card

4

A memory card must be formatted with this camera before use.

1 Press **MENU**.

The **1** menu appears.

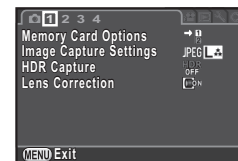

2 Turn or to display **4** menu.

3 Use **▲▼** to select [Format] and press **▶**.

The [Format] screen appears.

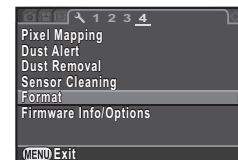

4 Use **▲▼** to select the memory card slot to format and press **▶**.

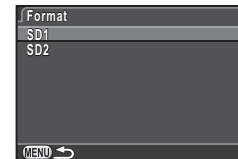

5 Press ▲ to select [Format] and press OK.

Formatting starts.

When formatting is completed, the 4 menu reappears.

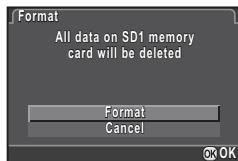

6 Press MENU.

The camera returns to standby mode.

Caution

- Do not remove the memory card while formatting. The card may be damaged.
- Formatting deletes all data, both protected and unprotected.

Memo

- When a memory card is formatted, the volume label "645Z" is assigned to the card. When this camera is connected to a computer, the memory card is recognized as a removable disk with the name "645Z".

Diopter Adjustment

You can adjust the diopter from approximately -3.5 to $+2.0$ m⁻¹.

- 1 Turn the diopter adjustment ring until the focusing brackets on the focusing screen are in focus while looking through the viewfinder.

Turn the diopter adjustment ring clockwise for a negative value and counterclockwise for a positive value.

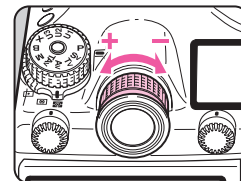

Attaching the Large Eyecup

Attach the Large Eyecup 645 O-EC107 as needed.

- 1 Slightly stretch the rim of the large eyecup and attach it on the camera, covering over the standard eyecup.

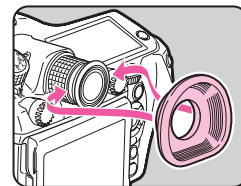

Testing Your Camera

Shooting

Take some test pictures to ensure that the camera is functioning properly.

- 1 Turn the camera on.
- 2 Turn the Stills/Movie switching dial to .

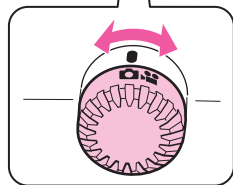
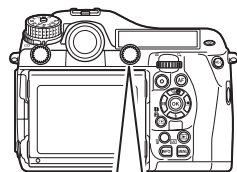

- 3 Turn the mode dial while pressing the mode dial lock button.

Mode dial lock button

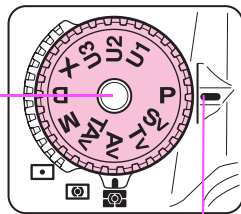

Dial indicator



The selected exposure mode is displayed on the monitor (Guide Display).
➤ Guide Display settings ( p.R30)







- 4 View the subject through the viewfinder and press the shutter release button.

The captured image appears on the monitor (Instant Review).

Available operations during Instant Review

	Deletes the image.
	Magnifies the image.
	Saves the RAW image (only when a JPEG image was taken and the data remains in the buffer).

Memo

- You can display the preview image on the monitor and check the depth of field before shooting. (p.67)
- You can set the operation and display settings during Instant Review in [Instant Review] of the 4 menu. ( p.R19)
- You can change the settings for the in-focus beep in [Sound Effects] of the 1 menu. ( p.R29)

Shooting with Live View

1 Press **LV** in Step 4 on p.38.

The Live View image is displayed on the monitor.

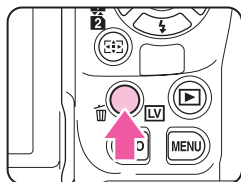



2 Position the subject inside the AF frame on the monitor and press the shutter release button halfway.



AF frame

Available operations during Live View

OK	Magnifies the image. Use  to change the magnification (up to 16×). Use  to change the area to magnify. Press  to return the display area to the center. Press OK to return to 1× image display.
LV	Exits the Live View shooting.

Subsequent steps are the same as shooting with the viewfinder.

Reviewing Images

You can play back captured images.

1 Press .



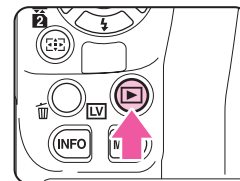









The camera enters playback mode and the most recently captured image (image with the highest file number) is displayed on the monitor (single image display).



2 Review the captured image.



Available operations

 /  to the left	Displays the previous image.
 /  to the right	Displays the next image.
	Deletes the image. (p.73)
 to the right	Magnifies the image (up to 16×). (p.73) Use  to change the area to magnify. Press  to return the display area to the center. Press OK to return to the entire image display.
 to the left	Switches to the thumbnail display (p.74).
	Switches between the SD1 card and SD2 card.
	Saves the RAW image (only when a JPEG image was taken and the data remains in the buffer).
	Changes the type of information displayed (p.19).

Memo

- When **AE-L RAW** is displayed on the monitor, the JPEG image that was just taken can also be saved in RAW format (Save RAW Data).
- Refer to “Playback and Processing Functions” (p.71) for details on playback functions.
- Use the provided software “Digital Camera Utility 5” to play back images using a computer. ( “Using a Computer” p.85)

How to Change Function Settings

The camera functions and their settings can be selected and changed by using the following ways.

Direct keys	Press ▲▼◀▶ in standby mode.
Control panel	Press INFO in standby mode. (indicated with the  icon in this manual)
Menus	Press MENU .

Using the Direct Keys



You can use the direct keys in standby mode to directly set functions.

▲	Drive Mode	p.56
▼	Flash Mode	p.64
◀	White Balance	p.53
▶	Custom Image	p.68

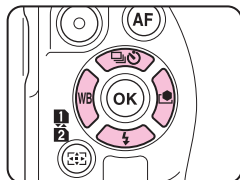

The following explains how to set the flash mode as an example.

1 Press ▼ in standby mode.

The Flash Mode setting screen appears.

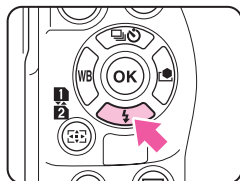

2 Use ◀▶ to select a flash mode.



3 Press OK.

The camera returns to standby mode.

Using the Control Panel

INFO

You can set frequently used shooting functions.

The following explains how to set [Slow Shutter Speed NR] as an example.

1 Press INFO in standby mode.

The control panel appears.

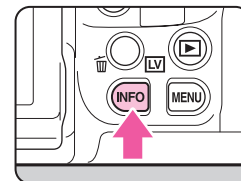

2 Use ▲▼◀▶ to select the item you want to change the setting for.

Only items which can be set can be selected.

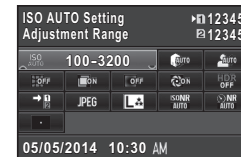

3 Use ☀ or ☂ to change settings.

Press OK to display the detailed setting screen for the selected item, and press OK again to confirm the setting change.

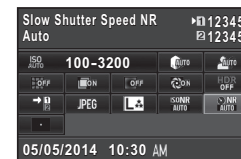

4 Press MENU.

The camera returns to standby mode.

Using the Menu

MENU

This section explains how to use the menus: [CAMERA] Rec. Mode], [MOVIE] Movie], [PLAYBACK] Playback], [SET-UP] Set-up] and [CUSTOM] Custom Setting]. The following explains how to set [Slow Shutter Speed NR] in the [CAMERA] menu as an example.

1 Press [MENU] in standby mode.

The [CAMERA] 1 menu appears on the monitor.

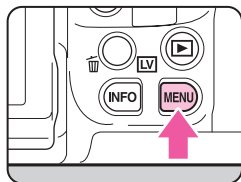

2 Press [RIGHT] or turn [WHEEL] to the right.

Each time [RIGHT] is pressed, the menu will change in the following sequence: [CAMERA] 2, [CAMERA] 3, [CAMERA] 4, [MOVIE] 1 ... [CAMERA] 1.

When [WHEEL] is turned to the right, the category will change in the following sequence: [CAMERA] 1, [MOVIE] 1, [PLAYBACK] 1, [SET-UP] 1, [CUSTOM] 1.

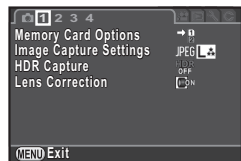

3 Use [UP/DOWN] to select an item and press [RIGHT].

Available settings are displayed. Any detailed settings are displayed in the submenu.



4 Use [UP/DOWN] to select an item and press [OK].

Next, set other items.

Press [MENU] to exit the menu and return to the screen that was displayed before selecting a menu item.

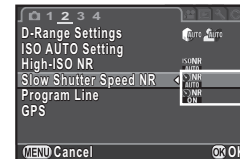

Caution

- Your settings may not be saved if the camera is turned off improperly (such as by removing the battery while the camera is on).

Memo

- Press [MENU] to display the first tab of the proper menu for the camera conditions at that time. To display the menu tab last selected first, set in [23. Save Menu Location] of the [CUSTOM] 4 menu. (p.R41)
- Settings are returned to their default values with [Reset] of the [SET-UP] 3 menu. (p.R35) To reset all the settings of the Custom Setting menu ([CUSTOM] 1-5) to the defaults, use [Reset Custom Functions] of the [CUSTOM] 5 menu. (p.R43)
- Refer to "Menu Reference" for details on each menu.
 - [CAMERA] Rec. Mode Menu (p.R15)
 - [MOVIE] Movie Menu (p.R24)
 - [PLAYBACK] Playback Menu (p.R26)
 - [SET-UP] Set-up Menu (p.R28)
 - [CUSTOM] Custom Setting Menu (p.R39)

3

Shooting Functions

Focusing	44
Exposure Setting	47
Movie Recording	51
White Balance	53
Drive Mode	56
Flash Mode	64
Preview	67
Custom Image	68

Focusing

Selecting the Focus Mode

- 1 Switch the focus modes between AF and MF on the lens.

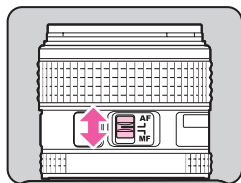

The autofocus method for shooting with the viewfinder differ from that for shooting with Live View.

Shooting with the viewfinder	TTL phase-matching autofocus: Select from A.F.S or A.F.C . Set the focusing area using the AF points. (p.45) Faster autofocus performance than contrast detection AF is possible.
Shooting with Live View	Contrast detection AF: Face Detection and Tracking are available. (p.46)

Memo

- You can use the **AF** button to focus on the subject. The **AF** button operation can be set in [Button Customization] of the **C4** menu. (p.R20)
- You can adjust the AF focus position with [24. AF Fine Adjustment] in the **C4** menu. (p.R42)

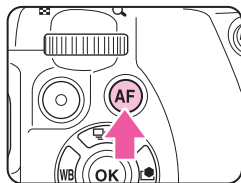

Setting the AF Mode when Shooting with the Viewfinder

- 1 Use the AF mode switching dial on the camera to select either **A.F.S** or **C**.

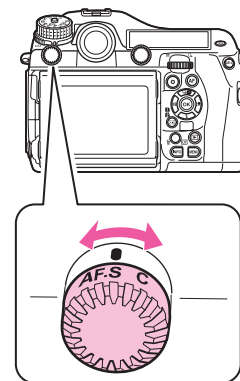

A.F.S Autofocus/ Single mode	Locks the focus at the position where the subject is in focus.
C (A.F.C) Autofocus/ Continuous mode	Continuously adjusts the focus to keep the subject in focus. The shutter can be released even if the subject is not in focus. The camera automatically tracks the subject if the subject is determined to be a moving object during focusing.

Memo

- The settings for AF operations can be set in the **C3** menu. (p.R40)



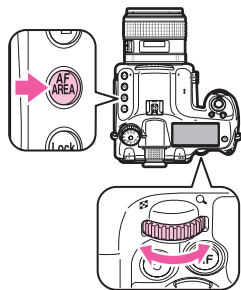

Selecting the Focusing Area (AF Point)



1 Turn  while pressing .





The AF area appears on the status screen and LCD panel.



 Auto (27 AF Points)	Out of the 27 AF points, the camera automatically selects the optimum focusing area. (Default setting)
 Zone Select	Out of the selected 9 AF points, the camera automatically selects the optimum focusing area.
 Select	Sets the focusing area to the user selected point from 27 points.
 Expanded Area AF (S)	Sets the focusing area to the user selected point from 27 points. When the subject happens to move out of the selected focusing area after being focused, 8 peripheral points are used as back-up points. Not available in A.F.S. mode.
 Expanded Area AF (M)	Sets the focusing area to the user selected point from 27 points. When the subject happens to move out of the selected focusing area after being focused, 24 peripheral points are used as back-up points. Not available in A.F.S. mode.

 Expanded Area AF (L)	Sets the focusing area to the user selected point from 27 points. When the subject happens to move out of the selected focusing area after being focused, 26 peripheral points are used as back-up points. Not available in A.F.S. mode.
 Spot	Sets the focusing area to the center of the 27 points.





Proceed to Step 2 when a mode other than  or  is selected.

2 Select the desired AF point.











The AF point appears in the viewfinder.



Available operations

	Changes the AF point.
	Returns the AF point to the center.
	Switches the function of the arrow keys () to that for Change AF Point or the direct key operation.

Memo

- When the AF point can be changed,  appears in the viewfinder.
- You can also set the AF point with [AF Active Area] on the control panel.
- You will hear a beep when the function of  is switched by pressing . You can change the setting with [Sound Effects] in the .1 menu. ( p.R29)
- To enable changing the AF point (disable the direct key operation) any time the focusing area selection mode is set to , , , , or , set in [26. 4-way Controller Options] of the **C4** menu. ( p.R42)
- Some AF points cannot be selected depending on the lens or accessories used. (p.28)

Setting the AF Mode during Live View



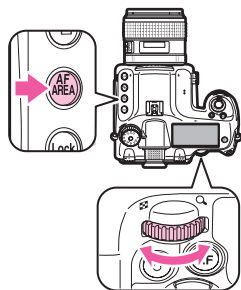

You can select an autofocus mode when shooting with Live View.

- 1 Turn  while pressing .



The screen for selecting an autofocus mode appears.



 Face Detection	Detects and tracks faces of people. (Default setting) The main face detection frame for AF and AE is displayed in yellow.
 Tracking	Tracks the subject in focus. The shutter can be released even if the subject is not in focus.
 Multiple AF Points	Sets the focusing area to the desired area. The sensor is divided into 35 areas (7 horizontal by 5 vertical), and you can select a wider or narrower focusing area by using 1, 9, 15, or 21 of those 35 available areas.
 Select	Sets the focusing area by the number of pixels.
 Spot	Sets the focusing area to a limited area at the center.

Proceed to Step 2 if  or  is selected.

- 2 Press .



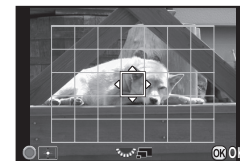

The screen to set the AF area is displayed.

- 3 Select the AF area.

Use the frame that appears on the monitor to change the position and size of the AF area.



Available operations

- | | |
|---|---|
|   | Changes the position of the AF area. |
|  | Increases/reduces the size of the AF area (when  is selected). |
|  | Returns the AF area to the center. |





- 4 Press .

The AF area is set.

Caution

- When  is selected, the focus lock operation (composition adjustment with the half press of the shutter release button) does not work.

Memo

- You can also select an autofocus mode for Live View in [Contrast AF] of [Live View] in the 3 menu or [Contrast AF] in the control panel. ( p.R18)
- When [Focus Peaking] of [Live View] in the 3 menu or [Focus Peaking] in the control panel is set to on, the outline of the subject in focus is emphasized and makes it easier to check the focus. ( p.R18)



Exposure Setting

Selecting the Metering Mode

1 Turn the metering mode switching dial.

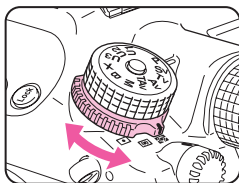
The set metering mode is displayed on the status screen, Live View screen and in the viewfinder.



 Multi-segment	Meters the brightness in multiple different zones of the sensor. In backlit locations, this mode automatically adjusts exposure.
 Center-weighted	Meters the brightness with an emphasis on the center of the sensor. The sensitivity increases at the center and no automatic adjustment is performed even in backlit conditions.
 Spot	Meters the brightness only within a limited area at the center of the sensor. Useful when the subject is small.

Memo

- You can link the metering point and the AF point. Set in [5. Link AE and AF Point] of the **C1** menu. ( p.R39)

Exposure Metering Timer

Set the exposure metering time with [3. Meter Operating Time] of the **C1** menu. ( p.R39)



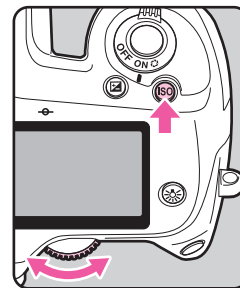

Setting the Sensitivity

You can set the sensitivity to [AUTO] or a value in the range equivalent to ISO 100 to 204800 (ISO 100 to 3200 for  mode).

- ### 1 Turn while pressing **ISO**.
- Press  while pressing **ISO** to switch to [AUTO].





Memo

- Set the range of automatic sensitivity adjustment with [ISO AUTO Setting] in the 2 menu or on the control panel. ( p.R17)
- You can set the sensitivity in increments of 1 EV or in accordance with the EV Steps setting for exposure. Set from [2. Sensitivity Steps] of the **C1** menu. ( p.R39)
- You can reduce noise at high sensitivity with [High-ISO NR] in the 2 menu or on the control panel. ( p.R17)
- The framerate for Continuous Shooting may slow down when the sensitivity is high.







Changing the Exposure Mode

The following are the available exposure modes.

(✓ : Available × : Not available)



Exposure Mode	Function	EV Compensation	Change Shutter Speed	Change Aperture Value	Change Sensitivity
P Program Automatic Exposure	Automatically sets the shutter speed and aperture value according to the program line. You can use  or  to switch between shutter priority and aperture priority.	✓	✓	✓	✓
Sv Sensitivity Priority Automatic Exposure	You can set the desired sensitivity.	✓	×	×	Other than AUTO
Tv Shutter Priority Automatic Exposure	You can set the desired shutter speed.	✓	✓	×	✓
Av Aperture Priority Automatic Exposure	You can set the desired aperture value.	✓	×	✓	✓
TAv Shutter & Aperture Priority Automatic Exposure	Automatically sets the sensitivity according to the set shutter speed and aperture value.	✓	✓	✓	AUTO only
M Manual Exposure	You can set exposure parameters.	✓	✓	✓	Other than AUTO
B Bulb Exposure	Bulb shooting	×	×	✓	Other than AUTO
X Flash X-sync Speed	The shutter speed is locked at 1/125 seconds. Use this when using a flash that does not automatically set the sync speed.	✓	×	✓	Other than AUTO
U1/U2/U3 User settings	Lets you capture images with the previously-saved exposure mode and settings.	—	—	—	—

Memo

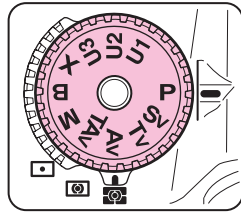

- Set the program line in [Program Line] of the 2 menu. ( p.R18)
- The sync speed of **X** can be changed in [25. Flash Sync Speed] of the 4 menu. ( p.R42)
- Save the settings to **U1**, **U2**, or **U3** in [Save USER Mode] of the 4 menu. ( p.R22)

1 Turn the mode dial while pressing the mode dial lock button.

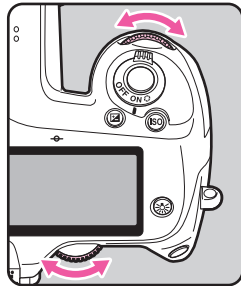

2 Use  or  to change settings.



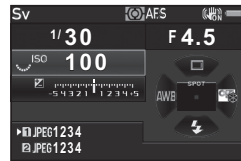

 and/or  appear on the status screen next to the setting that is being changed.

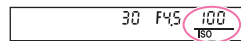

The value that can be changed is underlined in the viewfinder.





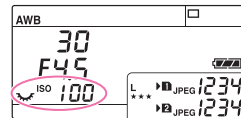



 and/or  appear on the LCD panel for the value that can be changed.



During Live View,  appears for the value that can be changed.



Memo



- The settings for exposure can be specified in increments of 1/3 EV steps. In [1. EV Steps] of the **C1** menu, you can change the adjustment steps to 1/2 EV steps. ( p.R39)
- A proper exposure may not be obtained with the selected shutter speed and aperture value when the sensitivity is set to a certain sensitivity value.
- In **M** or **X** mode, the difference from the proper exposure is displayed on the EV bar scale while the exposure is adjusted.
- In **B** mode, the drive mode cannot be set to Continuous Shooting, Multi-exposure+Continuous, Interval Shooting, Interval Composite, or Exposure Bracketing.
- For each exposure mode, you can set the camera operation for when  or  is turned or  is pressed. Set in [E-Dial Programming] of the  menu. ( p.R20)

EV Compensation

The compensation value can be set between -5 and +5 EV (-2 and +2 EV in  mode).

1 Turn while pressing .

 is displayed on the status screen, Live View screen, LCD panel and in the viewfinder during compensation.

Press  while pressing  to return to 0.0.

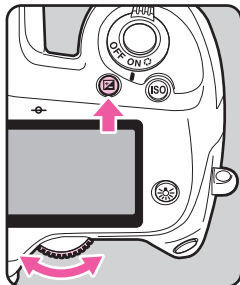

AE Lock





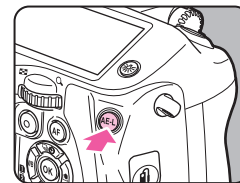

AE Lock is the function that locks the exposure prior to taking the picture.

1 Press .

 is displayed on the status screen, Live View screen, LCD panel and in the viewfinder when AE Lock is set.



Memo

- The exposure remains in memory for twice the amount of the exposure metering timer, even after you take your finger off .
- You will hear a beep when  is pressed. You can change the setting with [Sound Effects] in the  1 menu. ( p.R29)
- When AE Lock is set in **M** mode, you can change the shutter speed and aperture value while maintaining the exposure value.
- AE Lock is not available in **B** or **X** mode.
- When any of the following operations are performed, AE Lock is canceled.
 - When  is pressed again
 - When , **MENU**, or **INFO** is pressed
 - When the mode dial is turned
 - When the lens is changed
 - When the aperture ring of the lens with an aperture **A** position is set to **A** or is switched to a position other than **A**
- When using a zoom lens whose maximum aperture varies depending on the focal length, the shutter speed and aperture value change depending on the zooming position while AE Lock is engaged. However, the exposure value does not change and a picture is taken at the brightness level when AE Lock is set.
- Exposure can be locked when focus is locked. Set in [4. AE-L with AF Locked] of the **C1** menu. ( p.R39)

Movie Recording

- 1** Turn the Stills/Movie switching dial to .

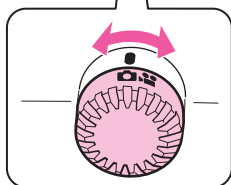
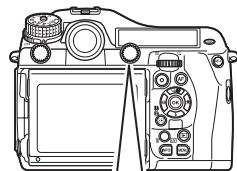

Live View is displayed.

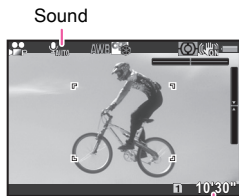

Recordable Time

- 2** Focus on the subject.

In **AF** mode, press the shutter release button halfway.

- 3** Press .

Movie recording starts.

In the upper left area of the monitor, "REC" blinks and the size of the file being recorded is displayed.

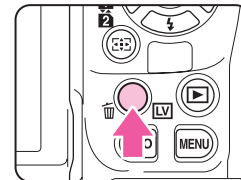





- 4** Press  again.

Movie recording stops.

Caution

- When recording a movie with sound, the camera operation sounds are also recorded.
- If the internal temperature of the camera becomes high during recording, the recording may be terminated.

Memo

- Recording can also be started or stopped by pressing the shutter release button fully.
- You can change the movie settings in the  1 menu or from the control panel. ( p.R24) When [Exposure Setting] is set to ,  or , you can set the exposure before shooting.
- You can record a movie continuously up to 4 GB or 25 minutes. When the memory card is full, recording stops.

Using an External Microphone

You can connect a commercially available stereo microphone to the microphone terminal on the camera. Using an external microphone can also help to reduce the possibility of recording camera operation sounds. The following specifications are recommended for external microphones.

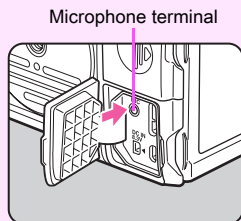

Plug	Stereo mini plug ($\phi 3.5$ mm)
Format	Stereo electret condenser
Power	Plug-in Power Method (operating voltage of 2.0 V or lower)
Impedance	2.2 k Ω

If the external microphone is disconnected during recording, no sound will be recorded.

Playing Back Movies

- 1 Display the movie to play back in single image display of the playback mode.



Available operations

	Plays back/pauses a movie.
	Forwards a frame (when paused).
Press and hold	Fast-forwards playback.
	Reverses a frame (when paused).
Press and hold	Fast-reverses playback.
	Stops playback.
	Adjusts the volume (21 levels).
	Saves the displayed frame as a JPEG file (when paused).

Memo

- In [Movie Edit] of the playback mode palette, movies can be divided or selected frames can be deleted. (p.81)

White Balance

The following settings are available.

Setting		Color Temperature
AWB	AWB Auto White Balance (default setting) A Multi Auto White Balance	Approx. 4,000 to 8,000K
	Daylight	Approx. 5,000K
	Shade	Approx. 8,000K
	Cloudy	Approx. 6,000K
	Fluorescent - Daylight Color	Approx. 5,700K
	Fluorescent - Daylight White	Approx. 4,700K
	Fluorescent - Cool White	Approx. 4,200K
	Fluorescent - Warm White	Approx. 3,500K
	Tungsten	Approx. 2,850K
	Flash	Approx. 5,400K
CTE	Color Temperature Enhancement	–
	Manual White Balance 1 to 3	–
K	Color Temperature 1 to 3	Approx. 2,500 to 10,000K

Memo

- When **A** is set, even if various light sources are present at the shooting location, the camera automatically adjusts the white balance according to the light source of each area. (Not available in mode.)

1 Press in standby mode.

The White Balance setting screen appears.

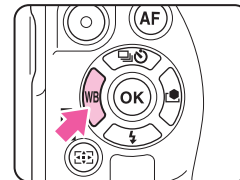

2 Select the White Balance.

For AWB, , and **K**, press and then use to select the White Balance.



Available operations when shooting with the viewfinder

Main switch to Uses Digital Preview to preview the background image with the white balance setting applied.

AE-L Saves the preview image (only when the image can be saved).

Proceed to Step 5 if you do not need to fine-tune the white balance.

3 Press **INFO**.

The fine-tuning setting screen appears.

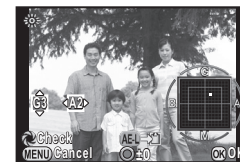

Available operations

Adjust: Green-Magenta

Adjust: Blue-Amber

Resets the adjustment value to the default setting.

4 Press **OK**.

The screen of Step 2 reappears.

5 Press OK .

The camera returns to standby mode.

Memo

- The settings for the white balance can be set in the **C2** menu. (📖 p.R40)

Manual White Balance

You can save up to three manual white balance settings.

1 Select WB in Step 2 on p.53 and press \blacktriangledown .**2 Select from $\text{WB} 1$ to $\text{WB} 3$.****3 Under the light you wish to measure the white balance of, select a white area as the subject, and press the shutter release button fully.**

The captured image is displayed.

[The operation could not be completed correctly] appears when measuring is unsuccessful. Press OK to remeasure the white balance.

4 Use \blacktriangle \blacktriangledown \blacktriangleleft \blacktriangleright to specify the measuring range.**5 Press OK .**

The White Balance setting screen reappears.

Saving the White Balance Settings of a Captured Image

You can copy the white balance settings of an image captured with this camera and save them as Manual White Balance.

1 In single image display of the playback mode, display the image with the white balance settings you want to copy and then press \blacktriangledown .

The playback mode palette appears.

2 Select WB (Save as Manual WB) and press OK .

The save confirmation screen appears.

3 Select the “Manual” number 1, 2 or 3 to save the settings.

Use WB to select a different image.

**4 Press OK .**

The white balance settings of the selected image is saved as Manual White Balance and the camera switches to standby mode.

Caution

- The fine-tuned white balance value used when shooting is not saved.

Color Temperature



You can save up to three color temperature settings.
(The default setting is [5000K].)

- 1 Select **K** in Step 2 on p.53, and press **▼**.
- 2 Select from **K1** to **K3**.
- 3 Press **INFO**.
- 4 Adjust the color temperature.

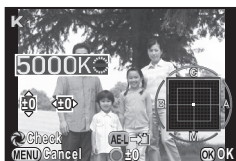
Set the color temperature value within the range from 2500K to 10000K.





Available operations

	100 Kelvin units
	1000 Kelvin units
	Fine-tunes the color temperature.









- 5 Press **OK**.
The White Balance setting screen reappears.

Memo





- Select [Mired] in [13. Color Temperature Steps] of the **C2** menu to set the color temperature in mired units. The color temperature can be changed in 20 mired units with , and 100 mired units with . However, figures are converted to and displayed in Kelvin. ( p.R40)

Drive Mode

You can choose from the following drive modes.

Single Frame Shooting (□)	Normal capture mode
Continuous Shooting ()	Continuously takes pictures while the shutter release button is kept pressed. The number of pictures that can be taken continuously varies according to the shutter speed.
Self-timer ()	Releases the shutter about 12 seconds or 2 seconds after the shutter release button is pressed.
Remote Control ()	Enables shooting with remote control. Select from [Remote Control], [Remote Control (3 sec. delay)] or [Remote Continuous Shooting].
Multi-exposure ()	Creates a composite picture by taking multiple images and merging them into a single image. Select from [Multi-exposure], [Multi-exposure +Continuous], [Self-timer+Multi-exposure] or [Remote Control+Multi-exposure].
Interval Shooting ()	Takes pictures at a set interval from a set time.
Interval Composite ()	Takes still images at a set interval and merges them into a single image. Star and moon trails can be captured in one image.
Interval Movie Record ()	Takes still images at a set interval from a set time and saves them as a single movie file. Available only in  mode.

Memo

- Only  (Remote Control Off),  or  can be selected in  mode.
- The Drive Mode setting is saved even after the power is turned off. If [Drive Mode] is set to off in [Memory] of the  4 menu, the setting returns to Single Frame Shooting when the power is turned off. (p.R22)
- When the drive mode that employs the self-timer or remote control is selected, exposure may be affected by the light entering through the viewfinder. In such a case, use the AE Lock function. (p.50)

Caution

- There are restrictions on some drive modes when used in combination with some other functions. (p.R44)

Continuous Shooting

1 Press in standby mode.

The Drive Mode setting screen appears.

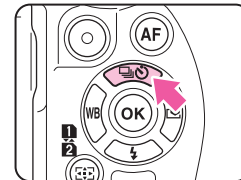

2 Select and press .

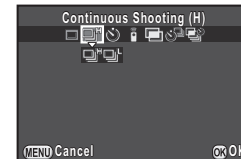

3 Select or and press .

The camera returns to standby mode.

Memo

- When the AF mode is set to **A.F.S.**, the focus position is locked in the first frame.
- The framerate may slow down when the sensitivity is high.

Self-timer



1 Press **▲** in standby mode.

The Drive Mode setting screen appears.

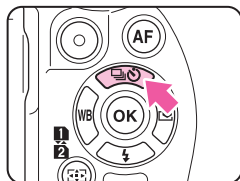

2 Select and press **▼**.



3 Select or and press **OK**.

The camera returns to standby mode.

4 Press the shutter release button halfway, then fully.

The self-timer lamp blinks.

The shutter will be released about 12 seconds or 2 seconds.

Remote Control



1 Press **▲** in standby mode.

The Drive Mode setting screen appears.

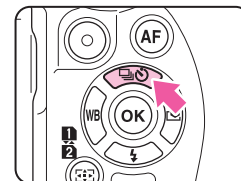

2 Select and press **▼**.

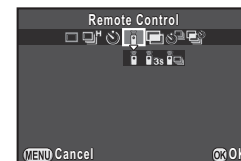

3 Select , , or and press **OK**.

The camera returns to standby mode.

The self-timer lamp blinks.

4 Press the shutter release button halfway.

5 Point the remote control unit towards the remote control receiver on the front or back of the camera, and press the shutter release button on the remote control unit.

Memo

- The maximum operating distance of the remote control unit is approx. 4 m from the front of the camera and approx. 2 m from the back of the camera.
- To adjust focus with remote control, set in [19. AF with Remote Control] of the **C3** menu. (p.R41)
- When using the Remote Control Waterproof O-RC1, the autofocus system can be operated with the  button. The **Fn** button cannot be used.

Multi-exposure



1 Press ▲ in standby mode.

The Drive Mode setting screen appears.

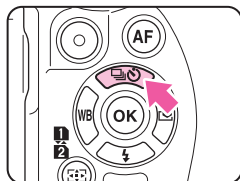

2 Select [Multi-exposure] and press ▼.

3 Select [Average], [Additive], [Bright] or [Composite Mode], and press ▼.

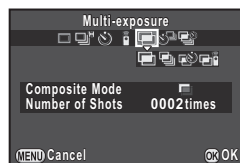

4 Select [Composite Mode].

	Average	Creates a composite image with the average exposure.
	Additive	Creates a composite image with the cumulatively added exposure.
	Bright	Creates a composite image that combines only bright parts.

5 Specify [Number of Shots].

Select from 2 to 2000 shots.

6 Press OK.

The camera returns to standby mode.

7 Press the shutter release button to start shooting.

Instant Review is displayed.

Available operations during Instant Review

	Discards pictures taken up to that point and takes pictures again from the first picture.
MENU	Saves pictures taken up to that point and displays the menu.

After the set number of pictures are taken, the camera returns to normal capture mode.

Caution

- Multi-exposure cannot be used with [HDR Capture] in the 1 menu at the same time. The mode set last is used.
- [Lens Correction] in the 1 menu is not available when Multi-exposure is set.

Interval Shooting



1 Press **▲** in standby mode.

The Drive Mode setting screen appears.

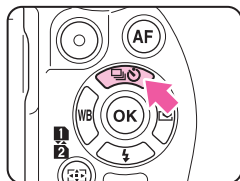

2 Select and press **▼**.

3 Set the shooting conditions.

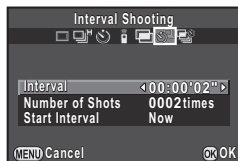

Interval	Select from 2 seconds to 24 hours.
Number of Shots	Select from 2 to 2000 shots.
Start Interval	Select whether to take the first picture now or at a set time. When [Set Time] is selected, set the time at which to start shooting in [Start Time].

4 Press **OK** to finish setting.

The camera returns to standby mode.

5 Press the shutter release button to start shooting.

When [Start Interval] is set to [Now], the first picture is taken.
When set to [Set Time], shooting starts at the set time.

To cancel shooting, press **(MENU)** in standby mode.

After the set number of pictures are taken, the camera returns to normal capture mode.

Memo

- A new folder is created when Interval Shooting is performed, and the captured images are saved there. When shooting in a different drive mode after performing Interval Shooting, a new folder will be created again.
- The shortest interval time that can be set for [Interval] is 30 seconds when [HDR Capture] is set in the  1 menu.

Interval Composite



1 Press **▲** in standby mode.

The Drive Mode setting screen appears.

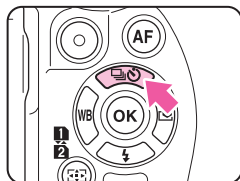

2 Select and press **▼**.

3 Set the shooting conditions.

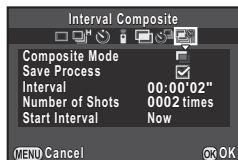

Composite Mode	Select from [Average], [Additive] or [Bright]. (Refer to "Multi-exposure" (p.58).)
Save Process	Select <input checked="" type="checkbox"/> to save the image in the process of composition.
Interval	Select from 2 seconds to 24 hours.
Number of Shots	Select from 2 to 2000 shots.
Start Interval	Select whether to take the first picture now or at a set time. When [Set Time] is selected, set the time at which to start shooting in [Start Time].

4 Press **OK** to finish setting.

The camera returns to standby mode.

5 Press the shutter release button to start shooting.

When [Start Interval] is set to [Now], the first picture is taken.

When set to [Set Time], shooting starts at the set time.

To cancel shooting, press **MENU** in standby mode.

After the set number of pictures are taken, the camera returns to normal capture mode.

Memo

- When [Save Process] is set to , a new folder is created and the composite image is saved there. When shooting in a different drive mode after performing Interval Composite, a new folder will be created again.
- Mount the camera on a tripod during Interval Composite.

Interval Movie Record



In mode, you can use [Interval Movie Record] to take still pictures at a set interval from a set time and save them as a single movie file (Motion JPEG, file extension: .AVI).

1 Turn the Stills/Movie switching dial to and press .

The Drive Mode setting screen appears.

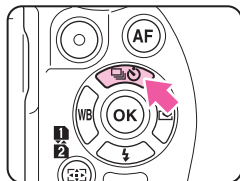
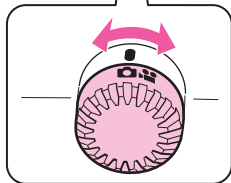
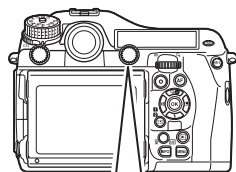

2 Select and press .

3 Set the shooting conditions.



Recorded Pixels	Select from , , or .
Interval	Select from 2 sec., 5 sec., 10 sec., 20 sec., 30 sec., 1min., 5 min., 10 min., 30 min., or 1hr.
Recording Time	Set the time from the start to the end of recording. Select from 14 seconds to 99 hours. The time that can be set varies depending on the [Interval] setting.
Start Interval	Select whether to take the first picture now or at a set time. When [Set Time] is selected, set the time at which to start shooting in [Start Time].

4 Press to finish setting.

The camera returns to standby mode.

5 Press the shutter release button to start shooting.

When [Start Interval] is set to [Now], the first picture is taken. When set to [Set Time], shooting starts at the set time.

Instant Review is displayed, and then the monitor turns off.

After the set number of pictures are taken, the camera returns to standby mode.

Memo

- The shortest interval time that can be set for [Interval] is 30 seconds when [HDR Capture] is set in the 1 menu.

Exposure Bracketing



You can use Exposure Bracketing to take 2 (standard exposure and underexposure, or standard exposure and overexposure), 3 or 5 images with different exposure levels.

This function can be used with Continuous Shooting, Self-timer, or Remote Control set by pressing ▲.

1 Turn while pressing to set the number of shots.

Check the setting on the LCD panel.

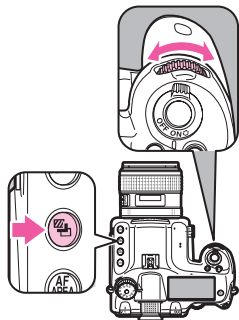

Right (clockwise) OFF → 3 → 5 → 2 → -2 → OFF
 Left (counterclockwise) OFF → -2 → 2 → 5 → 3 → OFF

2 Turn while pressing to set the bracket value.

EV Steps	Compensation Value
1/3 EV	±0.3, ±0.7, ±1.0, ±1.3, ±1.7, ±2.0
1/2 EV	±0.5, ±1.0, ±1.5, ±2.0

Press  while pressing  to return to [OFF] and [-].

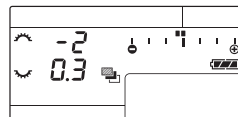

2 images (underexposed) at 0.3 EV

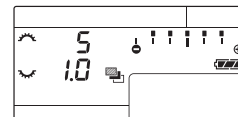



5 images at 1.0 EV

3 Press the shutter release button fully.

Select [OFF] in Step 1 to finish shooting with Exposure Bracketing.

Memo

- Set the auto bracketing order with [8. Bracketing Order] in the **C2** menu. ( p.R40)
- Set the EV step interval with [1. EV Steps] in the **C1** menu. ( p.R39)
- Set [9. One-Push Bracketing] in the **C2** menu to shoot all frames with one press of the shutter release button. ( p.R40)
- If you take your finger off the shutter release button before shooting of the set number of images is completed, the next bracket setting will remain effective for twice the amount of the exposure metering time.
- You can combine Exposure Bracketing with the P-TTL auto flash to change the flash output continuously. Confirm that the flash unit is fully charged before shooting each frame.

Caution

- This function is not available in **B** mode.
- This function cannot be used with Multi-exposure, Interval Shooting, or Interval Composite. The function set last is used.

Mirror Lock-up Shooting

This raises the mirror.

This function can be used with another drive mode set by pressing ▲.

1 Turn the Mirror Up dial.

The camera is ready to raise the mirror.

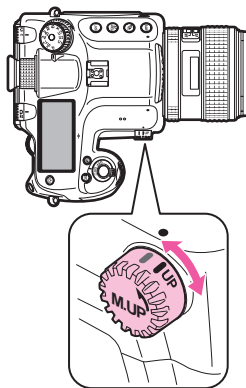

2 Press the shutter release button fully.

The mirror is raised.

3 Press the shutter release button fully again.

The mirror returns to its original position after an image is taken. To exit Mirror Lock-up Shooting, return the Mirror Up dial to its original position.

Memo

- The mirror automatically returns to its original position if 5 minutes elapse after the mirror is raised or the Auto Power Off function is activated. Depending on the shooting conditions, the mirror may return to its original position before 5 minutes elapse.
- To disable the Mirror Up dial operation, set in [27. Mirror Up Operation] of the C4 menu. (p.R42)

Caution

- Mirror Lock-up Shooting is not available when shooting with Live View. When the mirror is raised, the Live View image is not displayed even if [LV] is pressed.
- Turning the mode dial or adjusting the lens aperture ring when the mirror is raised lowers the mirror.
- The image preview is not available when the mirror is raised.
- The mirror is not raised during Interval Shooting or Interval Composite even when the Mirror Up dial is set to the “UP” position.

Shake Reduction

The Shake Reduction function is available when a lens with the SR system is used in [CAMERA] mode. Refer to the SR-supported lens manual for details on using the function. The Shake Reduction function is automatically turned off when Self-timer, Remote Control, Interval Movie Record, or Mirror Lock-up Shooting is set. In [CAMERA] mode, the Shake Reduction function can be activated from [Movie SR] of the [CAMERA] 1 menu. (p.R25)

Flash Mode

Attaching a Flash

- 1 Remove the hot shoe cover of the camera.

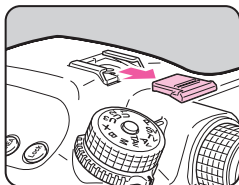

- 2 Attach the flash and turn on the camera.

Caution

- Do not use high-voltage or high-current external flashes. They may cause the camera to malfunction.
- A flash with reversed polarity (the center of the hot shoe or sync plug has a negative symbol) cannot be used, as this may damage the camera or flash.
- Linked functions do not work.
- To prevent vignetting caused by Trailing Curtain Sync from occurring, it is recommended to take a test shot using a shutter speed one stop slower than the flash sync speed.

Using a Sync Cord

You can connect a sync cord to the sync socket on the camera.

Sync socket

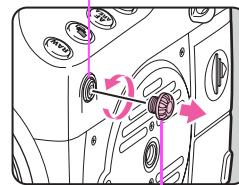

Sync socket 2P cap

Memo

- The flash connected to the sync socket can be discharged in Modeling Flash or Test Flash mode by pressing . The setting can be changed with [Illumination Button] in [Button Customization] of the 4 menu. (p.R20)

Caution

- The contact of the sync socket is not dust-proof or water-resistant. Attach the provided Sync socket 2P cap when not in use.

Setting the Flash Mode



The following flash modes are available. The flash modes that can be set vary depending on the exposure mode.

Flash Mode	Available Exposure Modes
Flash On	P, Sv, Tv, Av, TAv, M, B, X
Flash On+Red-eye Reduction	
Slow-speed Sync	P, Sv, Av
Slow-speed Sync+Red-eye	

1 Press in standby mode.

The screen to set a flash mode appears.

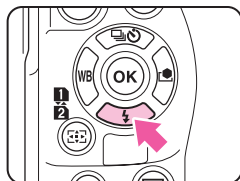

2 Select a flash mode.



3 To compensate the flash output, press and then use to adjust the value.



The compensation value varies depending on the setting of [1. EV Steps] (p.R39) in the **C1** menu.

EV Steps	Compensation Value
1/3 EV	-2.0, -1.7, -1.3, -1.0, -0.7, -0.3, 0.0, +0.3, +0.7, +1.0
1/2 EV	-2.0, -1.5, -1.0, -0.5, 0.0, +0.5, +1.0

Press to reset the value to 0.0.

4 Press .

The camera returns to standby mode.

Flash Compatibility Chart

The following functions are available when using this camera with our flashes.

(✓ : Available ×: Not available)

Function \ Flash	AF540FGZ II AF360FGZ II	AF540FGZ AF360FGZ	AF200FG AF160FC	AF500FTZ AF330FTZ	AF400FTZ AF240FT	AF400T AF280T AF200T	AF140C AF080C	AF200SA	AF200S AF160 AF140
P-TTL auto flash	✓ ^{*3}	✓ ^{*3}	✓ ^{*3}	×	×	×	×	×	×
External auto flash	×	✓	×	×	×	✓	×	✓	✓
Red-eye reduction	✓	✓	✓	×	×	×	×	×	×
Automatic switch of the shutter speed to the flash sync speed after the flash is charged	✓	✓	✓	✓	✓	✓	✓	✓	✓
Setting the aperture value in P or Tv mode	✓	✓	×	×	×	✓ ^{*4}	✓ ^{*4}	×	✓ ^{*5}
Slow-speed Sync flash	✓	✓	✓	✓	✓	✓ ^{*6}	✓ ^{*6}	✓	✓ ^{*5}
Trailing Curtain Sync flash ^{*1}	✓	✓	×	✓ ^{*7}	✓ ^{*7}	×	×	×	×
Contrast-control-sync flash	✓	✓	×	×	×	×	×	×	×
Slave flash	✓	✓	×	✓ ^{*8}	×	×	×	×	×
Flash Exposure Compensation	✓	✓	✓	×	×	×	×	×	×
AF Assist Light	✓	✓	×	✓	✓	×	×	×	×
Discharging a flash multiple times	✓	×	×	✓ ^{*8}	×	×	×	×	×
High-speed sync flash Wireless flash ^{*2}	✓	×	×	×	×	×	×	×	×

*1 There is a limit to the available shutter speeds.

*2 Two or more compatible flash units are required.

*3 Available only when using A645, A★645, FA645, FA★645, or D FA645 lenses.

*4 When the flash setting is MS or M, the aperture value changes automatically.

*5 When the flash setting is MS or M, the aperture value changes automatically in **Tv** mode.

*6 The aperture value changes automatically.

*7 The flash fully discharges.

*8 Unavailable for AF330FTZ.

Preview

Turn the main switch to  to use the preview function.
There are two preview methods.

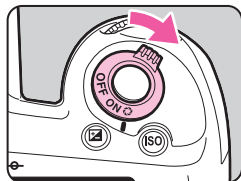

Optical Preview	For checking the depth of field with the viewfinder. (Default setting)
Digital Preview	For checking the composition, exposure and focus on the monitor. (The maximum display time: 60 seconds) You can magnify or save the preview image.

Setting the Preview Method



1 Select [Button Customization] in 4 menu and press .

The [Button Customization] screen appears.

2 Select [Preview Dial] and press .







The [Preview Dial] screen appears.

3 Select [Optical Preview] or [Digital Preview] and press .

4 Press three times.

The camera returns to standby mode.

Memo

- Optical Preview is always used when Multi-exposure, Interval Shooting, Interval Composite or Mirror Lock-up Shooting is used.
- The display settings and camera operation during Digital Preview can be changed in [Digital Preview] of the 4 menu. ( p.R19)
- The preview function can also be assigned to . ( p.R20)
You can easily switch between Optical Preview and Digital Preview after assigning different kinds of preview methods to the two controls,  of the main switch and .

Custom Image

Select the desired picture style from the following modes and enjoy taking pictures with a creative finishing tone.

Image Tone	Parameter
Bright/Natural/Portrait/ Landscape/ Vibrant/Radiant	Saturation: -4 to +4
	Hue: -4 to +4
	High/Low Key Adj: -4 to +4
	Contrast: -4 to +4
	Sharpness: -4 to +4
Muted/ Bleach Bypass	Saturation: -4 to +4
	Toning: Off/Green/Yellow/Orange/Red/Magenta/ Purple/Blue/Cyan
	High/Low Key Adj: -4 to +4
	Contrast: -4 to +4
	Sharpness: -4 to +4
Reversal Film	Sharpness: -4 to +4
Monochrome	Filter Effect: None/Green/Yellow/Orange/Red/ Magenta/Blue/Cyan/Infrared Filter
	Toning: Off/Green/Yellow/Orange/Red/Magenta/ Purple/Blue/Cyan
	High/Low Key Adj: -4 to +4
	Contrast: -4 to +4
	Sharpness: -4 to +4
Cross Processing	Random/Preset 1-3/Favorite 1-3 ^{*1}

*1 The settings of a captured image can be saved with [Save Cross Processing] of the playback mode palette. (p.69)

Memo

- By default, [Custom Image] is set to [Natural].

1 Press **▶** in standby mode.

The Custom Image setting screen appears.

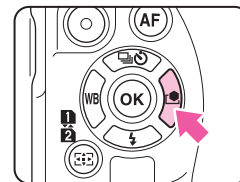

2 Select an image finishing tone.



Available operations when shooting with the viewfinder

Main switch to Uses Digital Preview to preview the background image with the selected effect applied.

AE-L Saves the preview image (only when the image can be saved).

Proceed to Step 6 if you do not need to change the parameters.

3 Press **INFO**.

The parameter setting screen appears.

4 Set the parameters.

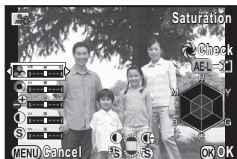

Available operations

▲▼	Selects a parameter.
◀▶	Adjusts the value.
☀	Switches between [Contrast], [Contrast Highlight Adjustment] and [Contrast Shadow Adjustment].
☂	Switches between [Sharpness], [Fine Sharpness] and [Extra Sharpness]. (Not available in mode.)
○	Resets the adjustment value to the default setting.

5 Press **OK**.

The screen of Step 2 reappears.

6 Press **OK**.

The camera returns to standby mode.

Memo

- When [Reversal Film] is selected and [White Balance] is set to [Auto White Balance], images are captured with an effect similar to using a daylight film.

Saving the Settings of a Captured Image

The outcome of Cross Processing varies each time a picture is taken. If you take a cross processed image that you like, you can save the Cross Processing settings used in that image so that you can repeatedly use the same settings.

1 Press ▼ in single image display of playback mode.

The playback mode palette appears.

2 Select (Save Cross Processing) and press **OK**.

The camera searches for cross processed images starting from the most recent image taken.

[No cross processed image] appears if there are no cross processed images.

3 Use to select a cross processed image.



4 Select the “Favorite” number 1, 2 or 3 to save the settings and press **OK**.

The settings of the selected image are saved as your “Favorite” settings.

Memo

- The saved Cross Processing settings can be loaded by selecting [Cross Processing] in Step 2 of “Custom Image” (p.68), and selecting one of the Favorite settings 1 to 3 for the parameter.

MEMO

4

Playback and Processing Functions











Setting the Playback Functions	72
Displaying a Single Image	73
Changing the Playback Method	74
Editing and Processing Images	77
Protecting Images	83
Connecting the Camera to an AV Device	84





Setting the Playback Functions

Playback functions can be set in the playback mode palette as well as the  menu.

Press  in single image display of the playback mode to display the playback mode palette.



Item	Function	Page
 Image Rotation *1	Changes the rotation information of images.	p.76
 Digital Filter *1	Processes images with digital filters.	p.79
 Color Moiré Correction *1 *2	Reduces color moiré in images.	p.78
 Resize *1 *2	Changes the number of recorded pixels of the image.	p.77
 Cropping *1	Crops out only the desired area of an image.	p.78
 Protect	Protects images from being accidentally erased.	p.83
 Slideshow	Plays back images one after another.	p.76
 Save as Manual WB *1	Saves the white balance settings of the captured image as Manual White Balance.	p.54
 Save Cross Processing	Saves the settings used for an image captured in Cross Processing mode of Custom Image as your "Favorite" settings.	p.69
 RAW Development *3	Develops RAW images into JPEG images and saves them as a new file.	p.82

Item	Function	Page
 Movie Edit *4	Divides a movie or deletes unwanted segments.	p.81
 Image Copy	Copies images between memory cards in SD1 and SD2 slots.	p.77
 Eye-Fi Image Transfer *5	Transfers selected images wirelessly using an optional Eye-Fi card.	 p.R34

*1 Not available when a movie is displayed.



*2 Not available when a RAW image is displayed.

*3 Available only when a RAW image is saved.

*4 Available only when a movie is displayed.

*5 Available only when an Eye-Fi card is inserted in the SD2 slot.

Memo

- The functions of the playback mode palette can be used only for the images saved on the memory card that is currently being played back. To use the functions for the images saved on the other memory card, switch to the other memory card slot with  during single image display, then display the playback mode palette.
- When saving images that have been edited with functions such as [Resize], you can choose whether to save the images to the memory card in the SD1 or SD2 slot if both cards are available for recording.
- Refer to "Menu Reference" for details on the  menus. ( p.R26)



Displaying a Single Image

Deleting Images One by One

Caution

- Deleted images cannot be restored.
- Protected images cannot be deleted. (p.83)

1 Display the image to delete in single image display.

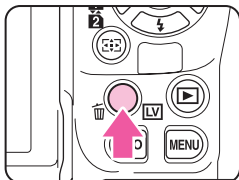

2 Press .

The delete confirmation appears.



3 Select [Delete] and press .

Memo

- Select the file format to delete for the images saved in RAW+ format.
- When deleting multiple images at once, refer to “Multi-image Display” (p.74) or “Folder Display” (p.75).
- To delete all images, use [Delete All Images] in the 1 menu. ( p.R27)

Zoom Display

Images can be magnified up to 16× in playback mode.







1 Display the image to magnify in single image display.

2 Turn to the right.





The image magnifies at each click.



Available operations

 to the right	Magnifies the image.
 to the left	Reduces the image.
	Changes the area to magnify.
	Returns to the entire image display.
	Displays the previous or next image without changing the magnification and the position of the image to magnify.
	Changes the type of information displayed.
	Switches between the memory cards to play back without changing the magnification and the position of the image to magnify.

Memo

- You can magnify the image by following the same procedure during Instant Review (p.38) or Digital Preview (p.67).
- You can set the initial magnification with [Quick Zoom] in the 1 menu. ( p.R26)
- When the image is magnified to the actual pixel size,  is displayed at the bottom right of the screen. If the  is turned to view the next or previous image during actual pixel size display, the next or previous image is displayed in the actual pixel size. The magnification for the actual pixel size varies depending on the number of recorded pixels of the image.

Changing the Playback Method

Multi-image Display



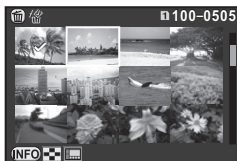

You can display 6, 12, 20, 35 or 80 thumbnail images at the same time. (Default setting: 12 Thumbnail Display)

1 Turn to the left in single image display.

The multi-image display screen appears.



Available operations

- | | |
|---|---|
|  | Moves the selection frame. |
|  | Shows the next/previous page. |
|  | Switches between the SD1 card and SD2 card. |
|  | Shows the display style selection screen. |

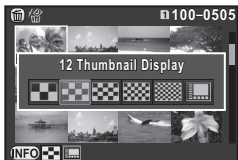

- | | |
|---|------------------------------|
|  | Deletes the selected images. |
|---|------------------------------|

2 Press .

The selected image appears in single image display.

Memo

- Icons such as  are not displayed on the thumbnail images when [80 Thumbnail Display] is selected.





Select & Delete

1 Press in Step 1 of “Multi-image Display”.

2 Select the images to delete.



Available operations

- | | |
|---|--|
|  | Moves the selection frame. |
|  | Confirms/cancels the selection of the image to delete. |
|  | Selects the range of images to delete. |
|  | Shows the selected image in single image display. Use  to select a different image. |

In the upper left area of the monitor, the number of selected images is displayed.

3 Press .

The delete confirmation screen appears.

4 Select [Delete] and press .

Memo

- You can select up to 500 images at a time.
- Protected images cannot be selected.
- You can delete the images selected individually along with the images selected by specifying the range to delete.
- Use the same steps to select multiple images for the following functions.
 - Image Copy (p.77)
 - RAW Development (p.82)
 - Protect (p.83)
 - Eye-Fi Image Transfer ( p.R34)

Folder Display

Images are grouped and displayed by folder in which they are saved.



- 1 Turn  to the left in Step 1 of “Multi-image Display”.

Up to eight folders are displayed at once.

- 2 Select a folder.



Available operations

	Moves the selection frame.
	Displays the images in the folder on the multi-image display screen.
	Deletes the folder and all the images in it.

Deleting a Folder

- 1 Select a folder to delete in Step 1 of “Folder Display” and press .

The delete confirmation screen appears.

- 2 Select [Delete] and press .

The selected folder and all the images in it are deleted.

When there are protected images in the folder, select [Delete all] or [Leave all].

Memo

- Refer to “Menu Reference” for details on folder names. ( p.R31)

Calendar Filmstrip Display

Images are grouped and displayed by shooting date.

- 1 Press  in Step 1 of “Multi-image Display”.

The display style selection screen appears.





- 2 Select [Calendar Filmstrip Display].

Images are displayed by shooting date.



Shooting date Thumbnail

Available operations

	Selects a shooting date.
	Selects an image taken on the selected shooting date.
 to the right	Displays the selected image in single image display. ( to the left: Returns to displaying images by shooting date.)
	Deletes the selected image.

- 3 Press .

The selected image appears in single image display.

Slideshow



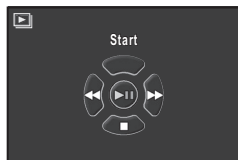

You can play back all images saved on a memory card successively.

1 Select in the playback mode palette.

The start screen is displayed and slideshow starts.



Available operations

	Pauses/resumes playback.
	Displays the next or previous image.
	Stops playback.
	Adjusts the volume of the movie.

After all images are played back, the camera returns to single image display.

Memo



- You can change the display settings for slideshow in [Slideshow] of the  1 menu. Slideshow can also be started from the Slideshow setting screen. ( p.R26)

Image Rotation

Image rotation information is saved according to the orientation of the camera when the image was shot. When [Auto Image Rotation] in the  1 menu is set to on (default setting), the image is automatically rotated based on the rotation information during playback.

The rotation information of an image can be changed by following the procedure below.

1 Display the image to edit in single image display.

2 Select in the playback mode palette.



The selected image is rotated in 90° increments and the four thumbnail images are displayed.

3 Select the desired rotation direction and press .

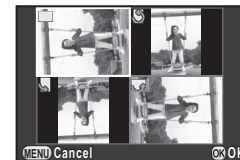

The image rotation information is saved.



Caution

- When [22. Save Rotation Info] is set to off in the **C**4 menu, image rotation information is not saved when shooting. ( p.R41)
- You cannot change the rotation information in the following cases.
 - Protected images
 - Images without a rotation information tag
- When [Auto Image Rotation] is set to off in the  1 menu ( p.R26)
- Movie files cannot be rotated.

Memo

- For images captured with [180° Rotation Info] in [Image Capture Settings] of the  1 menu set to on, the orientation of the camera when the image was taken is rotated 180° and saved as the rotation information. ( p.R15)

Editing and Processing Images

Image Copy

Copies images between memory cards in SD1 and SD2 slots.

1 Select an image saved on the memory card from which the images have to be copied, and display it in single image display.

2 Select  in the playback mode palette.

3 Select [Select image(s)] or [Select a folder] and press **OK**.

4 Select the image(s) or folder to copy.

Refer to Step 2 of “Select & Delete” (p.74) for how to select the image(s) or a folder.

5 Press **INFO**.

The save confirmation screen appears.

6 Select the location to save the image(s) or folder and press **OK**.

Memo

- A new folder is created at the selected location to save the copied image(s).

Resize/Cropping

Caution

- Only JPEG images captured with this camera can be resized or cropped. TIFF images and movies cannot be resized or cropped. RAW images cannot be resized.
- Images already resized or cropped to the minimum file size cannot be processed.

Resize

Changes the number of recorded pixels of the selected image, and saves it as a new file.

1 Display the image to edit in single image display.

2 Select  in the playback mode palette.

The screen to select the number of recorded pixels appears.

3 Use **◀ ▶** to select the number of recorded pixels.

You can select an image size smaller than that of the original image.



4 Press **OK**.

The save confirmation screen appears.

5 Select [Save to SD1] or [Save to SD2] and press **OK**.

Cropping

Crops out only the desired area of the selected image and saves it as a new image.

1 Display the image to edit in single image display.





2 Select  in the playback mode palette.

The cropping frame to specify the size and position of the area to crop appears on the screen.

3 Specify the size and position of the area to crop by using the cropping frame.



Available operations

	Changes the size of the cropping frame.
	Moves the cropping frame.
	Changes the aspect ratio or Image Rotation setting.
	Rotates the cropping frame (only when possible).

4 Press **OK**.

The save confirmation screen appears.

5 Select [Save to SD1] or [Save to SD2] and press **OK**.

Color Moiré Correction

Reduces color moiré in images.

1 Display the image to edit in single image display.

2 Select  in the playback mode palette.

If the image cannot be edited, [This image cannot be processed] appears.

3 Use **◀ ▶** to select the level and press **OK**.

The save confirmation screen appears.



4 Select [Save to SD1] or [Save to SD2] and press **OK**.

Caution

- The Color Moiré Correction function can be used only for the JPEG images captured with this camera. RAW/TIFF images and movies cannot be corrected.

Digital Filter

You can process captured images with digital filters. The following filters are available.

Filter Name	Effect	Parameter
Base Parameter Adj	Adjusts the parameters to create the desired image.	Brightness: -8 to +8
		Saturation: -3 to +3
		Hue: -3 to +3
		Contrast: -3 to +3
		Sharpness: -3 to +3
Extract Color	Extracts one or two specific colors and makes the rest of the image black and white.	Extracted Color 1: Red/Magenta/Blue/Cyan/Green/Yellow
		Extractable Range of Color 1: 1 to 5
		Extracted Color 2: OFF/Red/Magenta/Blue/Cyan/Green/Yellow
		Extractable Range of Color 2: 1 to 5
Toy Camera	Creates an image that looks as though it was shot with a toy camera.	Shading Level: Low/Medium/High
		Blur: Low/Medium/High
		Tone Break: Red/Green/Blue/Yellow
Retro	Creates an image with the look of an old photo.	Toning: B3 to A3
		Frame Composite: None/Thin/Medium/Thick
High Contrast	Enhances the contrast in the image.	1 to 5
Shading	Creates an image with darkened edges.	Shading Type: 4 types
		Shading Level: -3 to +3
Invert Color	Inverts image colors.	OFF/ON
Unicolor Bold	Extracts a specific color and makes the rest of the image black and white.	Red/Magenta/Blue/Cyan/Green/Yellow
Bold Monochrome	Creates a monochrome image and emphasizes the contrast.	Low/Medium/High

Filter Name	Effect	Parameter
Tone Expansion	Creates an image with a unique contrast.	Low/Medium/High
Sketch	Creates an image that looks as though it was drawn with a pencil.	Contrast: Low/Medium/High
		Scratch Effect: OFF/ON
Water Color	Creates an image that looks as though it was painted.	Intensity: Low/Medium/High
		Saturation: OFF/Low/Medium/High
Pastel	Creates an image that looks as though it was drawn with a crayon.	Low/Medium/High
Posterization	Lessens the tone of the image to create an image that looks as though it was hand-drawn.	1 to 5
Miniature	Blurs a part of the image to create a simulated miniature scene.	In-Focus Plane: -3 to +3
		In-Focus Width: Narrow/Middle/Wide
		In-Focus Plane Angle: Horizon/Vertical/Positive Slope/Negative Slope
		Blur: Low/Medium/High
Soft	Creates an image with a soft focus throughout the image.	Soft Focus: Low/Medium/High
		Shadow Blur: OFF/ON
Starburst	Creates an image with a special sparkling look by adding extra glitter to the highlights of night scenes or lights reflected on water.	Effect Density: Small/Medium/Large
		Size: Small/Medium/Large
		Angle: 0°/30°/45°/60°
Fish-eye	Creates an image that looks as though it was shot with a fish-eye lens.	Low/Medium/High
Slim	Changes the horizontal and vertical ratio of the image.	-8 to +8

1 Display the image to edit in single image display.

2 Select **0** in the playback mode palette.

The screen to select a filter appears.

3 Select a filter.

Use  to select a different image.

Proceed to Step 6 if you do not need to change the parameters.



4 Press **INFO**.

The parameter setting screen appears.

5 Set the parameters.

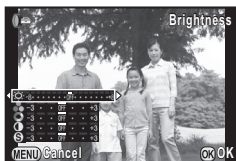

Available operations

▲▼	Selects a parameter.
◀▶	Adjusts the value.

6 Press **OK**.

The save confirmation screen appears.

7 Select [Apply additional filter(s)], [Save to SD1] or [Save to SD2], and press **OK**.

Select [Apply additional filter(s)] when you want to apply additional filters to the same image. The screen of Step 3 reappears.

Caution

- Only JPEG and RAW images captured with this camera can be edited with the digital filters. TIFF images cannot be edited.

Memo

- You can apply up to 20 filters to the same image.

Recreating Filter Effects

Retrieves the filter effects of the selected image and applies the same filter effects to other images.

1 Display a filter-processed image in single image display.

2 Select **0** in the playback mode palette.

3 Select [Recreating filter effects] and press **OK**.

The filter effects used for the selected image appear.



4 To check the parameter details, press **INFO**.

Press **INFO** again to return to the previous screen.



5 Press **OK**.

The image selection screen appears.

6 Use  to select an image for applying the same filter effects.

You can only select an image saved in the same memory card that has not been processed with a filter.



7 Press .

The save confirmation screen appears.

8 Select [Save to SD1] or [Save to SD2] and press .

 **Memo**

- If [Searching for the original image] is selected in Step 3, the original image prior to digital filter application can be retrieved.

Movie Edit

1 Display the movie to edit in single image display.

2 Select  in the playback mode palette.

The screen to edit a movie appears.





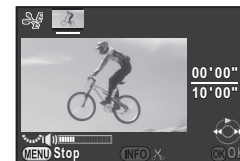

3 Select the point where you want to divide the movie.

The frame at the dividing point is displayed at the top of the screen.

Up to four points can be selected to divide the original movie into five segments.



Available operations

	Plays back/pauses a movie.
	Forwards a frame (when paused).
Press and hold 	Fast-forwards playback.
	Reverses a frame (when paused).
Press and hold 	Fast-reverses playback.
	Adjusts the volume.
	Confirms/cancels a dividing point.

Proceed to Step 7 if you do not want to delete any segment.

4 Press .

The screen to select segments to delete is displayed.

5 Use   to move the selection frame and press .

The segments to delete are specified. (Multiple segments can be deleted at once.)

Press  again to cancel the selection.

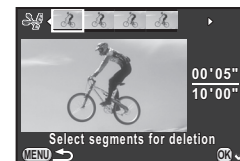

6 Press **MENU**.

The screen of Step 3 reappears.

7 Press **OK**.

The save confirmation screen appears.

8 Select **[Save to SD1]** or **[Save to SD2]** and press **OK**.

Memo

- Select dividing points in chronological order from the beginning of the movie. When canceling the selected dividing points, cancel each of them in reverse order (from the end of the movie to the beginning). In an order other than specified, you can neither select dividing points nor cancel the selections of the dividing points.

RAW Development

You can develop RAW images into JPEG or TIFF format.

1 Select **RAW** in the playback mode palette.

The screen for selecting a RAW image processing option appears.

2 Select the desired option and press **OK**.

Select single image	Develops an image.
Select multiple images	Develops up to 500 images with the same settings.
Select a folder	Develops up to 500 images in the selected folder with the same settings.

When **[Select single image]** is selected, proceed to Step 6. The image/folder selection screen appears.

3 Select the image(s) or a folder.

Refer to Step 2 of “Select & Delete” (p.74) for how to select the image(s) or a folder.

4 Press **INFO**.

The screen for selecting the parameter setting method appears.

5 Select the parameter setting method and press **OK**.



Develop images as shot	Allows you to change File Format, JPEG Recorded Pixels, and JPEG Quality.
Develop images with modified settings	Allows you to change Image Capture Settings (File Format, Aspect Ratio, JPEG Recorded Pixels, JPEG Quality, Color Space), Lens Correction (Distortion Correction, Lat-Chromatic-Ab Adj, Peripheral Illumin. Corr., Diffraction Correction, Color Fringe Correction), White Balance, Custom Image, Digital Filter, HDR, Sensitivity, High-ISO NR, and Shadow Correction.

6 Set the parameters.



Available operations

▲ ▼	Selects a parameter.
◀ ▶	Adjusts the value.
☀	Selects a different image (when in single image display).

For Image Capture Settings and Lens Correction, press ▶ and use ▲ ▼ to select an item.

For White Balance, Custom Image and Digital Filter, press ▶ to display the setting screen.

7 Press **OK**.

The save confirmation screen appears.

8 Select **[Save to SD1]** or **[Save to SD2]** and press **OK**.

When [Select single image] is selected, select [Continue] or [Exit], and press **OK**.

Caution

- Only RAW images captured with this camera can be developed. Images captured with other cameras cannot be processed on this camera.

Memo

- You cannot save the background image or use Digital Preview while setting the Custom Image or White Balance parameters.
- When the White Balance parameter is set to [Manual White Balance], press **INFO** to display the fine-tuning screen.
- The Digital Filter parameter cannot be applied to RAW images captured when [HDR Capture] of the **1** menu is set.
- When [Select multiple images] or [Select a folder] is selected in Step 2, a folder with a new number is created, and the JPEG images are stored in it.
- With the provided software “Digital Camera Utility 5”, you can develop RAW files on a computer. (p.88)

Protecting Images

You can protect images from being accidentally deleted.

Caution

- Even protected images are deleted if the inserted memory card is formatted.

1 Select in the playback mode palette.

The screen for selecting the unit for processing appears.

2 Select **[Select image(s)]** or **[Select a folder]** and press **OK**.



3 Select the image(s) or a folder.

Refer to Step 2 of “Select & Delete” (p.74) for how to select the image(s) or a folder.

Proceed to Step 5 if [Select a folder] is selected.

4 Press **INFO**.

The confirmation screen appears.

5 Select **[Protect]** and press **OK**.

To remove protection from the image, select [Unprotect].

Memo

- To protect all images stored in the memory card, select [Protect All Images] of the **1** menu. ( p.R26)

Connecting the Camera to an AV Device

Connect to an AV device, such as a TV, equipped with an HDMI terminal to display Live View images while shooting or to play back images in playback mode.

Make sure to have a commercially available HDMI cable equipped with an HDMI terminal (type D).

- 1 Turn the AV device and camera off.
- 2 Open the terminal cover of the camera, and connect the HDMI cable to the HDMI terminal.

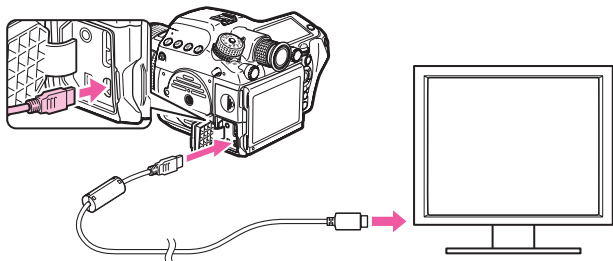

- 3 Connect the HDMI cable to the input terminal on the AV device.
- 4 Turn the AV device and camera on.

The camera turns on in HDMI mode, and the camera information is displayed on the screen of the connected AV device.

Caution

- While the camera is connected to an AV device, nothing is displayed on the camera monitor. Also, you cannot adjust the volume on the camera. Adjust the volume on the AV device.

Memo

- Check the operating manual of the AV device and select a suitable input terminal for connecting the camera.
- If you intend to use the camera continuously for a long period, use of the optional AC adapter kit is recommended.
- By default, the maximum resolution supported by both the AV device and camera is automatically selected. If it fails to play back images properly, change the setting in [HDMI Out] of the \curvearrowright 2 menu. ( p.R30)

5

Using a Computer

Connecting to a Computer	86
Using the Provided Software	88

Connecting to a Computer

The captured images can be transferred to a computer by connecting the camera using a USB cable and can be managed using the provided software.

System Requirements

We recommend the following system requirements to connect the camera to a computer or to use the provided software “Digital Camera Utility 5”.

Windows

OS	Windows 8.1 (32 bit/64 bit) / Windows 8 (32 bit/64 bit) / Windows 7 (32 bit/64 bit) / Windows Vista (32 bit/64 bit)
CPU	Intel Core 2 Quad or higher
RAM	4 GB or more
HDD	Program installation and start-up: 100 MB or more Space taken up on HDD (per file): [JPEG] Approximately 25 MB [TIFF] Approximately 150 MB [RAW] Approximately 70 MB
Monitor	1280×1024 pixels, 24 bit full-color or higher

Macintosh

OS	Mac OS X 10.9 / 10.8 / 10.7 / 10.6
CPU	Intel Core 2 Quad or higher
RAM	4 GB or more
HDD	Program installation and start-up: 100 MB or more Space taken up on HDD (per file): [JPEG] Approximately 25 MB [TIFF] Approximately 150 MB [RAW] Approximately 70 MB
Monitor	1280×1024 pixels, 24 bit full-color or higher

Memo

- QuickTime is required to play back movies transferred to a computer. You can download it from the following site:
<http://www.apple.com/quicktime/download/>

Connecting the Camera to a Computer

Connect the camera to a computer using an USB cable. Make sure to have a commercially available USB cable equipped with a micro B terminal.

- 1 Turn the computer on.
- 2 Turn the camera off.
- 3 Open the terminal cover of the camera, and connect the USB cable to the USB terminal.

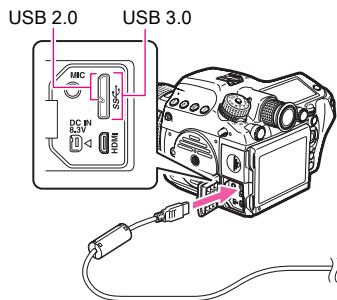

- 4 Connect the USB cable to the USB port of the computer.
- 5 Turn the camera on.
The camera is recognized as a removable disk.
If the "645Z" dialog appears, select [Open folder to view files].
- 6 Save the captured images to the computer.
- 7 Disconnect the camera from the computer.

Caution

- The camera cannot be operated while it is connected to a computer. To operate the camera, terminate the USB connection on the computer, then turn off the camera and remove the USB cable.

Memo

- When connected to a computer, use of the optional AC adapter kit is recommended.
- The USB connection mode when connecting the camera to a computer can be set in [USB Connection] of the \curvearrowright 2 menu. (📖 p.R30) Normally, you do not need to change the default setting ([MSC]).
- A memory card with a built-in wireless LAN "Eye-Fi card" (Wi-Fi transmission) or a "Flucard" compatible with this camera can be used. By using these cards, images can be transferred from the camera to a computer or other device via wireless LAN. (📖 p.R34)

USB Terminal

The micro B terminal supports both USB 3.0 cables and USB 2.0 cables. Both types can be used with this camera. If the host controller of the device to be connected to the camera supports USB 3.0, the use of a USB 3.0 cable makes the data transfer process faster.

Using the Provided Software

“Digital Camera Utility 5” is included on the provided CD-ROM (S-SW150). Using the Digital Camera Utility 5, you can manage images saved on a computer, develop RAW images taken with this camera and adjust the color of them.

- **Compatible file formats**

.jpg (JPEG), .tif (TIFF), .pef (RAW files in our original format), .dng (RAW files in DNG format)

Installing the Software

You can install the software from the provided CD-ROM.

- ① **Memo**

- When multiple accounts have been setup on the computer, log on with an account that has administrative rights before installing the software.
- The installation procedure varies depending on your operating environment. Refer to the following to install the software.

For Windows 7

1 Turn the computer on.

Shut down other software running.

2 Place the CD-ROM (S-SW150) into the optical drive.

The [Software Install] screen appears.

If the [Software Install] screen does not appear:

1 Click [Computer] from the Start menu.

2 Double-click the optical drive (S-SW150) icon.

3 Double-click [Setup.exe].

3 Click [32bit] or [64bit].

Select according to the operating environment.

The screen to select a desired language appears.



4 Select the desired language and click [OK].

The [InstallShield Wizard] screen appears in the selected language.

5 Click [Next].

Follow the instructions on the screen to perform subsequent steps.

1 Turn the Macintosh on.

Shut down other software running.

2 Place the CD-ROM (S-SW150) into the optical drive.

The CD-ROM icon appears on the desktop.

If the CD-ROM icon does not appear:

1 Select [Preferences] in the [Finder] menu.

2 Tick the [CDs, DVDs, and iPods] check box on the [General] tab.

3 Double-click the CD-ROM (S-SW150) icon.

4 Double-click the [Software Installer] icon.

5 Click [Digital Camera Utility 5].

Follow the instructions on the screen to perform subsequent steps.



Digital Camera Utility 5 Screen

When Digital Camera Utility 5 is launched, the following screen appears.

Memo

- The screenshots used in this explanation are for Windows.

Browser Mode

You can perform the file management functions such as viewing and managing the images.

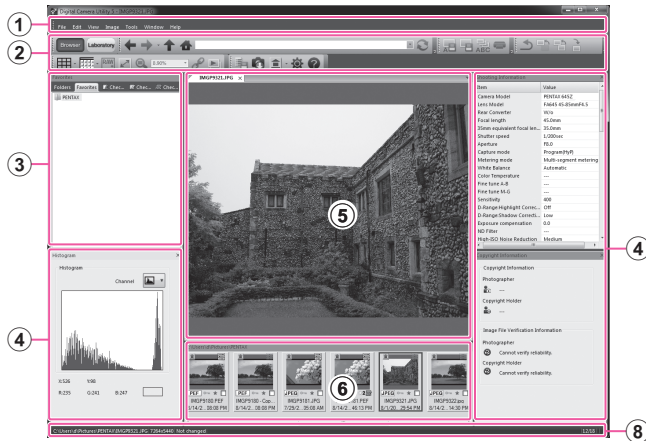

Laboratory Mode

The control panel for adjusting the image appears here.

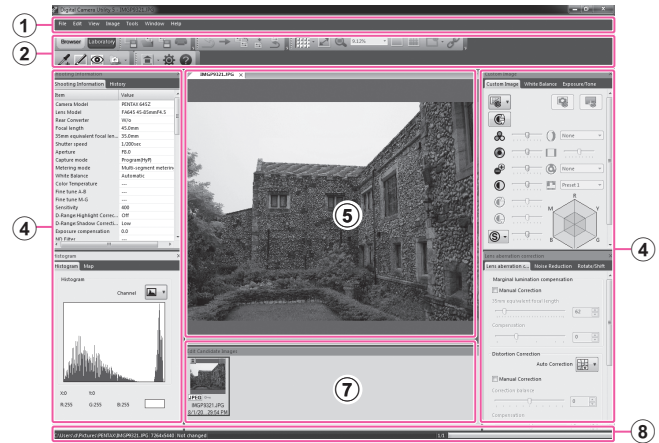

① Menu Bar

You can execute a function and change various settings here. For Macintosh, the Menu bar appears at the top of the desktop.

② Tool Bar

Frequently used functions are provided as Tool bar buttons.

③ Navigation Panel

This panel is only displayed in Browser mode. There are “Folders”, “Favorites”, “Checkmark 1”, “Checkmark 2”, and “Checkmark 3” panels.

④ Control Panel

The shooting information and settings of the selected image appear in this panel.

The control panel display varies depending on the mode.

⑤ Image View Page

The image selected from the image list is displayed.

When multiple image display pages are open, the images can be arranged left to right or up and down by dragging the tab. For Macintosh, select [Align images vertically] or [Align images horizontally] in the [Window] menu.

⑥ List of images in the current folder

The list of images in the selected folder appears here.

⑦ List of candidate images for editing

The list of images that can be edited appears here.

⑧ Status Bar

Information on the selected item appears.

Viewing the Help Menu

Refer to the Help menu for details on using the Digital Camera Utility 5 program.

1 Click the button on the Tool bar.

Or, select [Digital Camera Utility 5 Help] from the [Help] menu.

Regarding User Registration

In order to better serve you, we request that you complete the user registration.

1 Click [User Registration] on the [Software Install] screen.

A world map for Internet User Registration is displayed.



2 If your computer is connected to the Internet, click the displayed country or area and then follow the instructions to register your software.

Note that you can only register online if your country or area is shown.

MEMO

6

Appendix

Optional Accessories	94
Error Messages	97
Troubleshooting	98
Index	100
WARRANTY POLICY	105

Optional Accessories

Several accessories are provided for use with this camera. Please contact our service center for details regarding the accessories.

Products marked with an asterisk (*) are the same as those supplied with the camera.

Power Supply Accessories

Battery Charger kit K-BC90 (*)

(Kit includes Battery charger D-BC90 and AC plug cord.)

Rechargeable Lithium-ion Battery D-LI90 (*)

AC Adapter Kit K-AC132

(Kit includes AC adapter D-AC120 and AC plug cord.)

Lets you power this camera from an AC outlet.

Flash Accessories

Auto Flash AF540FGZ II

Auto Flash AF360FGZ II

The AF540FGZ II and AF360FGZ II are P-TTL auto flash units with a maximum guide number of approximately 54 and 36 (both ISO 100/m), respectively. Their features include slave-sync flash, contrast-control-sync flash, high-speed sync flash, wireless flash, slow-speed sync and trailing curtain sync flash.



AF540FGZ II



AF360FGZ II

Auto Flash AF200FG

The AF200FG is a P-TTL auto flash unit with a maximum guide number of approximately 20 (ISO 100/m). It features contrast-control-sync flash and slow-speed sync flash when combined with the AF540FGZ, AF540FGZ II, AF360FGZ or AF360FGZ II unit.



AF200FG

Auto Macro Flash AF160FC

The AF160FC is a flash system especially designed for macro photography to take close, shadowless pictures of small objects. It is compatible with existing TTL auto flash functions and can be used with a wide range of PENTAX cameras by using the provided adapter rings.



AF160FC

Hot Shoe Adapter FG

Extension Cord F5P



Hot Shoe Adapter Fg

Off-camera Shoe Adapter F

Use the adapters and cords to use the external flash away from the camera.



Off-camera Shoe Adapter F

For Viewfinder

Large Eyecup 645 O-EC107 (*)

Interchangeable Focusing Screen

AF Framed Matte DF-80 (*)

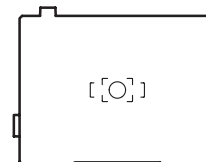

AF Cross-Lined Matte DG-80

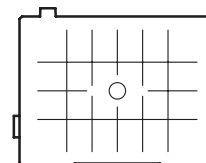

AF Golden Section Matte DK-80

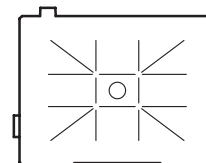

Cable Switch CS-205

Connect to the cable switch terminal and operate the camera shutter release button. The cord length is 0.5 m.



Remote Control

Used for remote control shooting.

Operating distance for remote control

From the front of camera: approx. 4 m

From the back of camera: approx. 2 m

Remote Control F



Remote Control Waterproof O-RC1



GPS Unit O-GPS1

By attaching the O-GPS1 to the hot shoe, the latitude, longitude, altitude, direction, and Coordinated Universal Time (UTC) can be recorded in the image file.

The Electronic Compass can be used with this camera. (📖 p.R18)



Strap

Camera Strap O-ST150 (*)

Other Accessories

Body Mount Cap 645 (*)

Hot Shoe Cover Fk (*)

Sync Socket 2P Cap (*)

Imagesensor Cleaning Kit O-ICK1

FLUCARD O-FC1



This SD memory card has a built-in wireless LAN (Wi-Fi transmission) function. Connect with a communication terminal such as a smartphone or tablet via wireless LAN and operate the communication terminal to shoot or view images. (📖 p.R34)



Error Messages

Error Messages	Description
Memory card full	The memory card is full and no more images can be saved. Insert a new memory card or delete unwanted files.
No image	There are no images that can be played back on the memory card.
This image cannot be displayed	You are trying to play back an image in a format not supported by this camera. You may be able to play it back on a computer.
No card in the camera	There is no memory card inserted in the camera.
Memory card error	The memory card has a problem, and image capture and playback are impossible. You may be able to play it back on a computer. Or, the camera failed to initialize the Eye-Fi function when using the Eye-Fi card. Press  .
Card is not formatted	The memory card you have inserted is unformatted or has been previously used on another device and is not compatible with this camera. Use the card after formatting it with this camera. (p.36)
Card is locked	The write-protect switch on the memory card you have inserted is locked. (p.4)
This image cannot be magnified	You are trying to magnify an image that cannot be magnified.
The image is protected	You are trying to delete an image that is protected. Remove protection from the image. (p.83)

Error Messages	Description
Not enough battery power remaining to activate Pixel Mapping	These messages appear when you try to perform Pixel Mapping or Sensor Cleaning, or to update the firmware if the battery level is insufficient. Install a fully charged battery.
Not enough battery power remaining to clean sensor	
Not enough battery power remaining to update the firmware	
Unable to update firmware. There is a problem with the firmware update file	Unable to update the firmware. The update file is damaged. Try downloading the update file again.
Image folder cannot be created	The maximum folder number (999) is being used, and no more images can be saved. Insert a new memory card or format the card.
Unable to store image	The image could not be saved because of a memory card error.
The operation could not be completed correctly	The camera was unable to adjust the manual white balance. Try the operation again.
No more images can be selected	You are trying to select more than the maximum number of images for Select & Delete, Protect, RAW Development, Image Copy, or Eye-Fi Image Transfer.
No image can be processed	There are no images that can be processed using the Digital Filter or RAW Development function.

Error Messages	Description
This image cannot be processed	Appears when you try to perform Digital Filter, Color Moiré Correction, Resize, Cropping, Save as Manual WB, RAW Development, or Movie Edit for images captured with other cameras, or when you try to perform Resize or Cropping for minimum file size images.
This function is not available in the current mode	You are trying to set a function that is not available for the exposure mode that is set.
The camera will turn off to prevent damage from overheating	The camera will turn off because its internal temperature is too hot. Leave the camera turned off until it has had time to cool down before turning on the camera again.
Set the Eye-Fi communication to "SELECT"	Images cannot be transferred when [Action Mode] is not set to [SELECT] in [Wireless Memory Card] of the  3 menu. ( p.R34)
Image not found	There are no images that can be transferred when an Eye-Fi card is used.
Cannot be selected	This folder cannot be selected because the number of files exceeds the maximum number allowed.

Caution













- Error messages related to a memory card appear for each card slot being used. If an error message appears, take the appropriate action for the respective card slot.

Troubleshooting

In rare cases, the camera may not operate correctly due to static electricity. This can be remedied by taking the battery out and putting it back in again. When the mirror remains in the UP position, take the battery out and put it back in again. Then, the mirror will retract when the camera is turned on again. If, after performing these procedures, the camera operates correctly, it does not require any repairs.

We recommend checking the following items before contacting a service center.

Problem	Cause	Remedy
The camera does not turn on.	Battery is not installed properly.	Check the orientation of the battery.
	The battery power is low.	Charge the battery.
The shutter cannot be released.	There is no available space on the memory card.	Insert a memory card with available space or delete unwanted images.
	Data is being processed.	Wait until processing is finished.
Autofocus does not work.	The subject is difficult to focus on.	AF cannot work well for low-contrast objects (the sky, white walls, etc.), dark colors, intricate designs, rapidly-moving objects or scenery shot through a window or a net-like pattern. Lock focus on another object located at the same distance as your subject, then aim at the target and take a picture. Alternatively, use MF .
	The subject is too close.	Move away from the subject and take a picture.

Problem	Cause	Remedy
The focus cannot be locked.	AF Mode of Live View is set to  (Tracking).	Set [Contrast AF] to  ,  ,  or  . (p.46)
The camera is not recognized when it is connected to a computer.	The USB connection mode is set to [PTP].	Set [USB Connection] to [MSC] in the  2 menu. ( p.R30)
Dust or dirt particles appear in images.	The CMOS sensor is dirty or dusty.	Activate [Dust Removal] from the  4 menu. The Dust Removal function can be activated every time the camera is turned on and off. ( p.R37) Refer to “Sensor Cleaning” if the problem persists. ( p.R37)
There are pixels in the monitor or captured images that do not light up or remain lit.	There are defective pixels in the CMOS sensor.	Activate [Pixel Mapping] from the  4 menu. ( p.R35) It takes about 30 seconds to correct the defective pixels, so be sure to install a fully charged battery.

Index

Symbols

menu	R5, R15
menu	R8, R24
menu	R8, R26
menu	R9, R28
C menu	R11, R39
mode	51

Numerics

180° Rotation Info	R15
1st Frame Action in AF.C	R41
4-way Controller Options	R42

A

AC adapter	32, 94
Accessories	10, 28, 94
Action in AF.C Continuous	R41
AdobeRGB	R41
AE Lock	50
AE-L with AF Locked	R39
AF area	45, 46
AF Button	R20
AF Fine Adjustment	R42
AF frame	39
AF Mode	44
AF point	45
AF with Remote Control	R41
AFC	44
AFS	44

AF.S Setting	R40
Aperture Priority Automatic Exposure mode	48
Aspect Ratio	78, 82
Auto (AF Active Area)	45
Auto EV Compensation	R39
Auto Image Rotation	R26
AUTO ISO Parameters	R17
Auto Power Off	R34
Auto Resize	R35
Auto Screen Rotation	R30
Auto White Balance (White Balance)	53
AV device	84
Av mode	48
AWB (White Balance)	53
AWB in Tungsten Light	R40

B

B mode	48
Base Parameter Adj (Digital Filter)	79
Battery	30
Battery level	31
Bleach Bypass (Custom Image)	68
Bold Monochrome (Digital Filter)	79
Bracketing	62
Bracketing Order	R40
Bright (Custom Image)	68
Brightness histogram	21
Bulb (B) Mode Options	R39
Bulb Exposure mode	48

Button	12
Button Customization	R20

C

C (AF Mode)	44
Cable switch	95
Cable switch terminal	11
Calendar Filmstrip Display	75
Card access lamp	11
Center-weighted metering	47
Changing the image size	77
Charging the battery	30
Charging time	30
City	R28
Cloudy (White Balance)	53
Color Fringe Correction	82
Color Moiré Correction	78
Color Space	R41
Color Temperature (White Balance)	55
Color Temperature Steps	R40
Computer	87
Connecting to a computer	86
Continuous mode	44
Continuous Shooting	56
Contrast (Custom Image)	68
Contrast AF	R18
Contrast detection AF	44
Control panel	17, 41
Copyright Holder	R33
Copyright Information	R33
Create New Folder	R32

Cropping	78
Cross Processing (Custom Image)	69
CTE (White Balance)	53
Custom Image	68
Custom setting menu.....	R11, R39

D

Date Adjustment	35, R28
Daylight (White Balance)	53
Default settings	R5
Delete	73, R27
Delete all images	R27
Delete an image.....	73
Deleting a folder.....	75
Destination.....	R29
Detailed Information Display.....	20
Developing RAW images.....	82
Dial.....	12
Dial indicator.....	38
Diffraction Correction.....	R16
Digital Camera Utility 5	90, 91
Digital Filter.....	79
Digital Preview	67, R19
Dioptr adjustment.....	37
Direct keys	41, R13
Display Color	R30
Display language	34, R28
Distortion Correction.....	R16
DNG.....	R15
D-Range Settings	R16
Drive Mode	56

DST (daylight saving time).....	R29
Dust Alert	R36
Dust Removal.....	R37
Dynamic range.....	R16

E

E-Dial Programming.....	R20
Electronic Compass	18, R18
Electronic Level.....	18, 23, R19
Enable/Disable Controls.....	R43
Error messages.....	97
EV bar scale.....	22
EV Compensation	50
EV Steps	49, R39
Exif.....	R33
Expanded Area AF (AF Active Area)	45
Exposure Bracketing.....	62
Exposure metering timer	47, R39
Exposure Mode	48
Exposure Mode (USER mode)	R15, R23
Exposure Setting (Movie).....	R24
Exposure warning	22
Extract Color (Digital Filter)	79
Eye-cup	37
Eye-Fi card.....	33, R34
Eye-Fi Image Transfer	R34

F

Face Detection (Contrast AF).....	46
File Format	R15
File Name	R32
File No.	R33
Filter Effect (Custom Image).....	68
Firmware Info/Options	R38
Fish-eye (Digital Filter)	79
Flash.....	64, 94
Flash (White Balance)	53
Flash compatibility.....	66
Flash compensation	65
Flash Mode.....	65
Flash On.....	65
Flash Sync Speed	48, R42
Flicker Reduction.....	R34
Flucard.....	33, 96, R34
Fluorescent - Cool White (White Balance)	53
Fluorescent - Daylight Color (White Balance)	53
Fluorescent - Daylight White (White Balance)	53
Fluorescent - Warm White (White Balance)	53
Focus Method.....	44
Focus Peaking.....	R18
Folder display	75
Folder Name.....	R31
Format	36, R38
Framerate	R24
Function settings	40

G			
GPS	R18		
GPS Time Sync	R18		
GPS unit	96		
Green button	R20		
Grid Display	R19, R26		
Guide Display	38, R30		
H			
HDMI Out	R30		
HDMI terminal	84		
HDR Capture	R16, R24		
Help	91		
High Contrast (Digital Filter)	79		
High/Low Key Adj (Custom Image)	68		
High-ISO NR	R17		
Highlight Alert	R19, R26		
Highlight Correction	R16		
Histogram Display	21, R19		
Hold AF Status	R41		
Hometown	34, R29		
Hue (Custom Image)	68		
I			
Illumination Button	R21		
Image Capture Settings	R15		
Image Copy	77		
Image finishing tone	68		
Image plane indicator	11		
Image Rotation	76		
Image storage capacity	R49		
Initial settings	34		
Initializing a memory card	36, R38		
Installing software	88		
Instant Review	38, R19		
Interchangeable focusing screen	95		
Interval Composite	60		
Interval Movie Record	61		
Interval Shooting	59		
Invert Color (Digital Filter)	79		
ISO AUTO Setting	R17		
ISO sensitivity	47		
J			
JPEG	R15		
K			
Kelvin	55, R40		
L			
Landscape (Custom Image)	68		
Language/言語	34, R28		
Language setting	34, R28		
Lat-Chromatic-Ab Adj	R16		
LCD Display	R30		
LCD Display Settings	R30		
LCD Panel	23		
LCD Panel Illumination	R41		
Lens	26		
Lens compatibility	28		
Lens Correction	R16		
Link AE and AF Point	R39		
Live View	16, 39, R18		
Locking exposure value	50		
LS lens	29		
M			
M mode	48		
MUP	63		
Macintosh	86		
Manual Exposure mode	48		
Manual White Balance	54		
Memory	R22		
Memory card	33		
Memory Card Options	R15, R24		
Menu	42, R5		
Menu operation	42, R14		
Meter Operating Time	R39		
Metering mode	47		
Microphone	52		
Miniature (Digital Filter)	79		
Mired	55, R40		
Mirror Up	63		
Mirror Up Operation	R42		
Mode dial	38, 49		
Mode dial lock button	38		
Monitor	15		
Monochrome (Custom Image)	68		
Motion JPEG	61		
Movie Capture Settings	R24		
Movie Edit	81		
Movie menu	R8, R24		
Movie mode	51		
Movie SR	R25		
MSC	R30		

Multi Auto White Balance (White Balance).....	53
Multi-exposure	58
Multi-image display	74
Multiple AF Points (Contrast AF)	46
Multi-segment metering	47
Muted (Custom Image).....	68

N

Names of parts	11
Natural (Custom Image)	68
Noise Reduction	R17

O

One Push File Format.....	R21
One-Push Bracketing.....	R40
Optical Preview	67

P

P mode	48
Pastel (Digital Filter)	79
PEF	R15
Peripheral Illumination Correction.....	R16
Photographer	R33
Pixel Mapping	R35
Pixels	R15
Playback	39
Playback Info Display selection screen	19
Playback menu	R8, R26
Playback mode	39
Playback mode palette	72, R13

Portrait (Custom Image).....	68
Posterization (Digital Filter)	79
Power	34
Power frequency	R34
Preview	67, R19
Preview Dial	67, R21
Program Automatic Exposure mode	48
Program Line.....	48, R18
Protect.....	83, R26
Protect All Images.....	R26
Provided software	88
PTP	R30

Q

Quality Level	R15
Quick Zoom.....	R26
QuickTime	86

R

Radiant (Custom Image)	68
RAW.....	R15
RAW/Fx Button	R20
Rec. Mode menu.....	R5, R15
Recordable time	51
Recorded Pixels	R15, R24
Recording Sound Level.....	R24
Red-eye Reduction	65
Remote Control	57, 96
Reset.....	R35, R43
Resize	77
Retro (Digital Filter).....	79
Reversal Film (Custom Image)	68

RGB histogram.....	21
Rotate Display 180°	R19
Rotation	76
Rotation Direction (E-Dial Programming).....	R20

S

Saturation (Custom Image)	68
Save as Manual WB	54
Save Menu Location.....	42, R41
Save RAW Data	38, 39, 40, R19
Save Rotation Info.....	R41
Save Settings (White Balance).....	54
Save USER Mode	R22
SD Memory Card.....	33
Select (AF Active Area)	45
Select (Contrast AF)	46
Select & Delete.....	74
Self-timer	57
Sensitivity	47, 82
Sensitivity Priority Automatic Exposure mode.....	48
Sensitivity Steps	R39
Sensor Cleaning.....	R37
Sequential Numbering.....	R33
Set-up menu.....	R9, R28
Shade (White Balance).....	53
Shading (Digital Filter).....	79
Shadow Correction.....	R16
Shake Reduction	63, R25, R43
Shake Reduction Options.....	R43
Sharpness (Custom Image).....	68

Shooting..... 38

Shooting Info Display..... 18

Shooting information..... 15

Shutter & Aperture Priority
Automatic Exposure mode..... 48

Shutter Priority Automatic
Exposure mode..... 48

Single image display..... 19, 39, 73

Single mode..... 44

Sketch (Digital Filter) 79

Slideshow 76, **R26**

Slim (Digital Filter) 79

Slow Shutter Speed NR..... **R17**

Slow-speed Sync..... 65

Soft (Digital Filter)..... 79

Sound 51

Sound Effects **R29**

Speaker 11

Specifications..... **R45**

Spot (AF Active Area)..... 45, 46

Spot metering 47

sRGB **R41**

Standby mode..... 15

Starburst (Digital Filter)..... 79

Status Screen 16

Stereo microphone 11

Stills/Movie switching dial 38, 51

Strap..... 26

Superimpose AF Area 22, **R40**

Sv mode 48

Switch 12

Switching between
the memory cards..... 39

Sync cord 64

Sync socket..... 64

Sync socket 2P cap..... 64

System requirements 86

T

TAv mode 48

Testing your camera 38

Text Size 35, **R29**

TIFF..... 82, **R15**

Time Setting **R29**

Tone Expansion (Digital Filter)..... 79

Toning (Custom Image) 68

Toy Camera (Digital Filter)..... 79

Tracking (Contrast AF)..... 46

TTL phase-matching autofocus..... 44

Tungsten (White Balance)..... 53

Tv mode..... 48

U

Unicolor Bold (Digital Filter) 79

USB Connection..... 87, **R30**

USB terminal..... 87

U1/U2/U3 mode..... 48, **R22**

User registration..... 91

User setting mode..... 48, **R22**

V

Vertical position 18

Vibrant (Custom Image) 68

Viewfinder..... 22

Volume **R24, R29**

Volume label..... 37

W

WARRANTY POLICY..... 105, **R55**

Water Color (Digital Filter)..... 79

WB Adjustable Range **R40**

WB When Using Flash **R40**

White Balance 53

Wi-Fi transmission..... **R34**

Windows 86

Wireless LAN..... **R34**

Wireless Memory Card..... **R34**

World Time **R28**

X

X mode..... 48

Z

Zone Select (AF Active Area)..... 45

Zoom display 73

WARRANTY POLICY

All our cameras purchased through authorized bona fide photographic distribution channels are guaranteed against defects of material or workmanship for a period of twelve months from the date of your purchase. Service will be rendered, and defective parts will be replaced without cost to you within that period, provided the camera does not show evidence of impact, sand or liquid damage, mishandling, tampering, battery or chemical corrosion, operation contrary to operating instructions, or modification by an unauthorized repair shop. The manufacturer or its authorized representatives shall not be liable for any repair or alterations except those made with its written consent and shall not be liable for damages from delay or loss of use or from other indirect or consequential damages of any kind, whether caused by defective material or workmanship or otherwise; and it is expressly agreed that the liability of the manufacturer or its representatives under all guarantees or warranties, whether expressed or implied, is strictly limited to the replacement of parts as hereinbefore provided. No refunds will be made on repairs by non-authorized service facilities.

Procedure During 12-month Warranty Period

Any camera which proves defective during the 12-month warranty period should be returned to the dealer from whom you purchased the camera or to the manufacturer. If there are no representatives of the manufacturer in your country, send the camera to the manufacturer, with postage prepaid. In this case, it will take a considerable length of time before the camera can be returned to you owing to the complicated customs procedures required. If the camera is covered by warranty, repairs will be made and parts replaced free of charge, and the camera will be returned to you upon completion of servicing. If the camera is not covered by warranty, regular charges of the manufacturer or of its representatives will apply. Shipping charges are to be borne by the owner. If your camera was purchased outside of the country where you wish to have it serviced during the warranty period, regular handling and servicing fees may be charged by the manufacturer's representatives in that country. Notwithstanding this, your camera returned to the manufacturer will be serviced free of charge according to this procedure

and warranty policy. In any case, however, shipping charges and customs clearance fees to be borne by the sender. To prove the date of your purchase when required, please keep the receipt or bills covering the purchase of your camera for at least a year. Before sending your camera for servicing, please make sure that you are sending it to the manufacturer's authorized representatives or their approved repair shops, unless you are sending it directly to the manufacturer. Always obtain a quotation for the service charge, and only after you accept the quoted service charge, instruct the service station to proceed with the servicing.

- **This warranty policy does not affect the customer's statutory rights.**
- **The local warranty policies available from our distributors in some countries can supersede this warranty policy. Therefore, we recommend that you review the warranty card supplied with your product at the time of purchase, or contact our distributor in your country for more information and to receive a copy of the warranty policy.**

For customers in USA
STATEMENT OF FCC COMPLIANCE

This device complies with Part 15 of the FCC Rules. Operation is subject to the following two conditions: (1) This device may not cause harmful interference, and (2) this device must accept any interference received, including interference that may cause undesired operation. Changes or modifications not approved by the party responsible for compliance could void the user's authority to operate the equipment. This equipment has been tested and found to comply with the limits for a Class B digital device, pursuant to part 15 of the FCC Rules.

These limits are designed to provide reasonable protection against harmful interference in a residential installation. This equipment generates, uses and can radiate radio frequency energy and, if not installed and used in accordance with the instructions, may cause harmful interference to radio communications. However, there is no guarantee that interference will not occur in a particular installation. If this equipment does cause harmful interference to radio or television reception, which can be determined by turning the equipment off and on, the user is encouraged to try to correct the interference by one or more of the following measures:

- Reorient or relocate the receiving antenna.
 - Increase the separation between the equipment and receiver.
 - Connect the equipment into an outlet on a circuit different from that to which the receiver is connected.
- * Consult the dealer or an experienced radio/TV technician for help.

For customers in Canada

This Class B digital apparatus complies with Canadian ICES-003.

Pour les utilisateurs au Canada

Cet appareil numérique de la classe B est conforme à la norme NMB-003 du Canada.

FOR CALIFORNIA, U.S.A. ONLY

Perchlorate Material-special handling may apply.

The lithium battery used in this camera contains perchlorate material, which may require special handling.

See www.dtsc.ca.gov/hazardouswaste/perchlorate

Declaration of Conformity
According to 47CFR, Parts 2 and 15 for
Class B Personal Computers and Peripherals

We: RICOH IMAGING AMERICAS CORPORATION

Located at: 633 17th Street, Suite 2600
Denver, Colorado 80202 U.S.A.
Phone: 800-877-0155
FAX: 303-790-1131

Declare under sole responsibility that the product identified herein complies with 47CFR Parts 2 and 15 of the FCC rules as a Class B digital device. Each product marketed is identical to the representative unit tested and found to be compliant with the standards. Records maintained continue to reflect the equipment being produced can be expected to be within the variation accepted, due to quantity production and testing on the statistical basis as required by 47CFR §2.909. Operation is subject to the following two conditions: (1) This device may not cause harmful interference, and (2) This device must accept any interference received, including interference that may cause undesired operation. The above named party is responsible for ensuring that the equipment complies with the standards of 47CFR §15.101 to §15.109.

Product Name: Lens-interchangeable medium-format digital SLR (Single Lens Reflex) Camera

Model Number: PENTAX 645Z

Contact person: Customer Service Manager

Date and Place: March, 2014, Colorado

Information for Users on Collection and Disposal of Old Equipment and Used Batteries



1. In the European Union

These symbols on the products, packaging and/or accompanying documents mean that used electrical and electronic equipment and batteries should not be mixed with general household waste.



Used electrical/electronic equipment and batteries must be treated separately and in accordance with legislation that requires proper treatment, recovery and recycling of these products.

By disposing of these products correctly you will help ensure that the waste undergoes the necessary treatment, recovery and recycling and thus prevent potential negative effects on the environment and human health which could otherwise arise due to inappropriate waste handling.

If a chemical symbol is added beneath the symbol shown above, in accordance with the Battery Directive, this indicates that a heavy metal (Hg = Mercury, Cd = Cadmium, Pb = Lead) is present in the battery at a concentration above an applicable threshold specified in the Battery Directive.

For more information about collection and recycling of used products, please contact your local authorities, your waste disposal service or the point of sale where you purchased the products.

2. In other countries outside the EU

These symbols are only valid in the European Union. If you wish to discard used products, please contact your local authorities or dealer and ask for the correct method of disposal.

For Switzerland: Used electrical/electronic equipment can be returned free of charge to the dealer, even when you don't purchase a new product. Further collection facilities are listed on the home page of www.swico.ch or www.sens.ch.



The CE Mark is a Directive conformity mark of the European Union.

MEMO



**RICOH IMAGING
COMPANY, LTD.**

2-35-7, Maeno-cho, Itabashi-ku,
Tokyo 174-8639, JAPAN
(<http://www.ricoh-imaging.co.jp>)

**RICOH IMAGING
EUROPE S.A.S**

112 Quai de Bezons, B.P. 204,
95106 Argenteuil Cedex, FRANCE
(<http://www.ricoh-imaging.fr>)

**RICOH IMAGING
DEUTSCHLAND GmbH**

Am Kaiserkai 1, 20457 Hamburg, GERMANY
(<http://www.ricoh-imaging.de>)

**RICOH IMAGING
UK LTD.**

PENTAX House, Heron Drive, Langley, Slough,
Berks SL3 8PN, U.K.
(<http://www.ricoh-imaging.co.uk>)

**RICOH IMAGING
AMERICAS CORPORATION**

633 17th Street, Suite 2600,
Denver, Colorado 80202, U.S.A.
(<http://www.us.ricoh-imaging.com>)

**RICOH IMAGING
CANADA INC.**

1770 Argentia Road Mississauga,
Ontario L5N 3S7, CANADA
(<http://www.ricoh-imaging.ca>)

**RICOH IMAGING
CHINA CO., LTD.**

23D, Jun Yao International Plaza, 789 Zhaojiabang Road,
Xu Hui District, Shanghai, 200032, CHINA
(<http://www.ricoh-imaging.com.cn>)

- Specifications and external dimensions are subject to change without notice.

RICOH

Medium Format Digital SLR Camera

PENTAX 645Z

Menu Reference

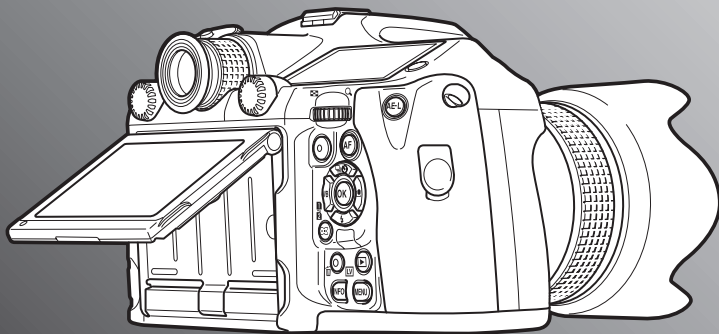

To ensure the best performance from your camera,
please read the operating manual before using the camera.

Thank you for purchasing our PENTAX 645Z medium format digital SLR camera. Please read this manual before using the camera in order to get the most out of all the features and functions. Keep this manual safe, as it can be a valuable tool in helping you to understand all the camera's capabilities.

Lenses you can use

In general, lenses that can be used with this camera are D FA645 and FA645 lenses, and 645 lenses that have an Aperture **A** (Auto) position. To use any other lens or accessory, see the Operating Manual (📖 p.28).

Regarding copyrights

Images taken with this camera that are for anything other than personal enjoyment cannot be used without permission according to the rights as specified in the Copyright Act. Please take care, as there are cases where limitations are placed on taking pictures even for personal enjoyment during demonstrations, performances or of items on display. Images taken with the purpose of obtaining copyrights also cannot be used outside the scope of use of the copyright as laid out in the Copyright Act, and care should be taken here also.

Trademarks

Microsoft, Windows and Windows Vista are registered trademarks of Microsoft Corporation in the United States of America and other countries. Macintosh, Mac OS, and QuickTime are trademarks of Apple Inc., registered in the U.S. and other countries.

Intel, Intel Core, and Pentium are trademarks of Intel Corporation in the U.S. and/or other countries.

SDXC Logo is a trademark of SD-3C, LLC.

Eye-Fi, the Eye-Fi logo and Eye-Fi *connected* are trademarks of Eye-Fi, Inc.

This product includes DNG technology under license by Adobe Systems Incorporated.

The DNG logo is either a registered trademark or trademark of Adobe Systems Incorporated in the United States and/or other countries.

HDMI, the HDMI logo and High-Definition Multimedia Interface are trademarks or registered trademarks of HDMI Licensing, LLC in the United States and/or other countries.

All other trademarks are the property of their respective owners.

This product supports PRINT Image Matching III. PRINT Image Matching enabled digital still cameras, printers and software help photographers to produce images more faithful to their intentions. Some functions are not available on printers that are not PRINT Image Matching III compliant.

Copyright 2001 Seiko Epson Corporation. All Rights Reserved. PRINT Image Matching is a trademark of Seiko Epson Corporation. The PRINT Image Matching logo is a trademark of Seiko Epson Corporation.

AVC Patent Portfolio License

This product is licensed under the AVC Patent Portfolio License for the personal use of a consumer or other uses in which it does not receive remuneration to (i) encode video in compliance with the AVC standard ("AVC video") and/or (ii) decode AVC video that was encoded by a consumer engaged in a personal activity and/or was obtained from a video provider licensed to provide AVC video. No license is granted or shall be implied for any other use.

Additional information may be obtained from MPEG LA, L.L.C. See <http://www.mpegla.com>.

To users of this camera

- Do not use or store this camera in the vicinity of equipment that generates strong electromagnetic radiation or magnetic fields. Strong static charges or the magnetic fields produced by equipment such as radio transmitters could interfere with the monitor, damage the stored data, or affect the camera's internal circuitry and cause camera misoperation.
- The liquid crystal panel used for the monitor is manufactured using extremely high precision technology. Although the level of functioning pixels is 99.99% or better, you should be aware that 0.01% or fewer of the pixels may not illuminate or may illuminate when they should not. However, this has no effect on the recorded image.
- In this manual, the generic term "computer(s)" refers to either a Windows PC or a Macintosh.
- In this manual, the term "battery(ies)" refers to any type of batteries used for this camera and its accessories.

There is a possibility that the illustrations and the display screen of the monitor in this manual are different from the actual ones.

Menu Reference Contents

Menu Descriptions and Default Settings

R5

Rec. Mode Menu	R5
Movie Menu	R8
Playback Menu	R8
Set-up Menu	R9
Custom Setting Menu	R11
Other Default Settings	R13
How to Use the Menu	R14

Rec. Mode Menu

R15

Exposure Mode	R15
Memory Card Options	R15
Image Capture Settings	R15
HDR Capture	R16
Lens Correction	R16
D-Range Settings	R16
ISO AUTO Setting	R17
High-ISO NR	R17
Slow Shutter Speed NR	R17
Program Line	R18
GPS	R18
Live View	R18
Electronic Level	R19

Instant Review	R19
Digital Preview	R19
E-Dial Programming	R20
Button Customization	R20
Memory	R22
Save USER Mode	R22

Movie Menu

R24

Exposure Setting	R24
Memory Card Options	R24
Movie Capture Settings	R24
Recording Sound Level	R24
HDR Capture	R24
Movie SR	R25

Playback Menu

R26

Slideshow	R26
Quick Zoom	R26
Grid Display	R26
Highlight Alert	R26
Auto Image Rotation	R26
Protect All Images	R26
Delete All Images	R27

Set-up Menu

R28

Language/言語	R28
Date Adjustment	R28
World Time	R28

Text Size	R29
Sound Effects	R29
LCD Display	R30
LCD Display Settings	R30
USB Connection	R30
HDMI Out	R30
Folder Name	R31
Create New Folder	R32
File Name	R32
File No.	R33
Copyright Information	R33
Flicker Reduction	R34
Auto Power Off	R34
Wireless Memory Card	R34
Reset	R35
Pixel Mapping	R35
Dust Alert	R36
Dust Removal	R37
Sensor Cleaning	R37
Format	R38
Firmware Info/Options	R38

C Custom Setting Menu

R39

1. EV Steps	R39
2. Sensitivity Steps	R39
3. Meter Operating Time	R39
4. AE-L with AF Locked	R39
5. Link AE and AF Point	R39

6. Auto EV Compensation	R39
7. Bulb (B) Mode Options	R39
8. Bracketing Order	R40
9. One-Push Bracketing	R40
10. WB Adjustable Range	R40
11. WB When Using Flash	R40
12. AWB in Tungsten Light	R40
13. Color Temperature Steps	R40
14. Superimpose AF Area	R40
15. AF.S Setting	R40
16. 1st Frame Action in AF.C	R41
17. Action in AF.C Continuous	R41
18. Hold AF Status	R41
19. AF with Remote Control	R41
20. Color Space	R41
21. LCD Panel Illumination	R41
22. Save Rotation Info	R41
23. Save Menu Location	R41
24. AF Fine Adjustment	R42
25. Flash Sync Speed	R42
26. 4-way Controller Options	R42
27. Mirror Up Operation	R42
28. Shake Reduction Options	R43
29. Enable/Disable Controls	R43
Reset Custom Functions	R43

Appendix

R44

Restrictions on the Combinations of Special Functions	R44
Main Specifications	R45
Index	R50
WARRANTY POLICY	R55

Regarding User Registration



In order to better serve you, we request that you complete the user registration, which can be found on the CD-ROM supplied with the camera (📄 p.91) or on our website.











Thank you for your cooperation.

Menu Descriptions and Default Settings

Rec. Mode Menu

Menu	Item	Function	Default Setting	Page	
☑1	Exposure Mode *1	Temporarily changes the exposure mode when the mode dial is set to U1 , U2 or U3 .	P	p.R15	
	Memory Card Options *2	Sets the recording method for when two memory cards are inserted.	Sequential Use	p.R15	
	Image Capture Settings	File Format *2	Sets the file format of images.	JPEG	p.R15
		JPEG Recorded Pixels *2	Sets the recording size of images saved in JPEG format.	<input type="checkbox"/>	
		JPEG Quality *2	Sets the quality of images saved in JPEG format.	★★★	
		RAW File Format	Sets the RAW file format.	PEF	
		180° Rotation Info	Rotates the image 180° and saves the rotated image.	Off	
	HDR Capture	HDR Capture *2	Sets the type of high dynamic range shooting.	Off	p.R16
		Exposure Bracket Value *2	Sets the range in which to change the exposure.	±2EV	
		Auto Align	Sets whether to automatically adjust the composition.	On	
	Lens Correction	Distortion Correction *2	Reduces distortions occurring due to lens properties.	Off	p.R16
		Lat-Chromatic-Ab Adj *2	Reduces lateral chromatic aberrations occurring due to lens properties.	On	
		Peripheral Illumin. Corr. *2	Reduces peripheral light fall-off occurring due to lens properties.	Off	
Diffraction Correction *2		Corrects the diffraction when the aperture is small.	On		
☑2	D-Range Settings *2	Expands the dynamic range and prevents bright and dark areas from occurring.	Auto/Auto	p.R16	
	ISO AUTO Setting *2	Sets the range of automatic correction in ISO AUTO and the manner in which the sensitivity is increased.	ISO 100 to ISO 3200/Standard	p.R17	
	High-ISO NR *2	Sets the Noise Reduction setting when shooting with a high ISO sensitivity.	Auto	p.R17	
	Slow Shutter Speed NR *2	Sets the Noise Reduction setting when shooting with a slow shutter speed.	Auto	p.R17	
	Program Line	Selects the program line.	Normal	p.R18	
	GPS	Sets the camera action for when the optional GPS unit is used.	–	p.R18	



Menu	Item	Function	Default Setting	Page	
 3	Live View	Contrast AF *2	Sets the AF Mode for shooting with Live View.	Face Detection	p.R18
		Focus Peaking *2	Emphasizes the outline of the subject in focus and makes it easier to check the focus.	Off	
		Grid Display	Displays the grid during Live View.	Off	
		Histogram Display	Displays the histogram during Live View.	Off	
		Highlight Alert	Bright (overexposed) areas blink red during Live View.	Off	
		Rotate Display 180°	Rotates the image 180° and displays the rotated image.	Off	
	Electronic Level	Viewfinder	Displays the electronic level on the EV bar scale in the viewfinder and/or LCD panel.	Off	p.R19
		Live View	Displays the electronic level during Live View.	On	
 4	Instant Review	Display Time	Sets the Instant Review display time.	1sec.	p.R19
		Zoom Instant Review	Sets whether to display a magnified image during Instant Review.	On	
		Save RAW Data	Sets whether to save the RAW image during Instant Review.	On	
		Delete	Sets whether to delete the image during Instant Review.	On	
		Histogram Display	Displays the histogram during Instant Review.	Off	
		Highlight Alert	Bright (overexposed) areas blink red during Instant Review.	Off	
	Digital Preview	Zoom Instant Review	Sets whether to display a magnified image during Digital Preview.	On	p.R19
		Save Preview Image	Sets whether to enable saving a preview image.	On	
		Histogram Display	Displays the histogram during Digital Preview.	Off	
		Highlight Alert	Bright (overexposed) areas blink red during Digital Preview.	Off	

Menu	Item	Function	Default Setting	Page	
 4	E-Dial Programming	P	Tv, Av, ➡P	p.R20	
		Sv	-, ISO, -		
		Tv	Tv , -, -		
		Av	-, Av , -		
		TAv	Tv , Av , PLINE		
		M	Tv , Av , PLINE		
		B	-, Av , -		
		X	-, Av , -		
		 P	-, -, -		
		 Av	-, Av , PLINE		
		 Av	Tv , Av , PLINE		
	 M	Tv , Av , PLINE			
	Rotation Direction	Reverses the effect obtained when  or  is turned.	Rotate Right		
	Button Customization	RAW/Fx Button	Sets the  operation.	One Push File Format	p.R20
		AF Button	Sets the  operation.	Enable AF1	
		Preview Dial	Sets the camera action for when the main switch is turned to the  position.	Optical Preview	
		Illumination Button	Sets the  operation.	LCD Panel Illumination	
Memory		Determines which settings to save when the power is turned off.	On for settings other than [HDR Capture]	p.R22	
Save USER Mode		You can save frequently used capture settings to U1 , U2 or U3 of the mode dial.	-	p.R22	

*1 Appears only when the mode dial is set to **U1**, **U2** or **U3**.

*2 Can also be set from the control panel.

Movie Menu





Menu	Item	Function	Default Setting	Page
 1	Exposure Setting *1	Sets the exposure mode for  mode.	Program AE	p.R24
	Memory Card Options *1	Selects one of memory cards inserted in SD1 and SD2 slots for recording movies.	SD1	p.R24
	Movie Capture Settings *1	Sets the number of recorded pixels and framerate.	 /30p	p.R24
	Recording Sound Level *1	Sets the Recording Sound Level and the volume level for recording.	Auto	p.R24
	HDR Capture *1	Sets the type of high dynamic range shooting when the drive mode is set to [Interval Movie Record].	Off/±2EV	p.R24
	Movie SR *1	Activates the Movie Shake Reduction function.	On	p.R25

*1 Can also be set from the control panel.

Playback Menu

Menu	Item	Function	Default Setting	Page	
 1	Slideshow	Display Duration	Sets an image display interval.	3sec.	p.R26
		Screen Effect	Sets a transition effect when the next image is displayed.	Off	
		Repeat Playback	Starts the slideshow again from the beginning after the last image is displayed.	Off	
		Auto Movie Playback	Plays back movies during the slideshow.	On	
	Quick Zoom	Sets the initial magnification when magnifying images.	Off	p.R26	
	Grid Display	Sets the grid style and color.	Off/Translucent black color	p.R26	
	Highlight Alert	Bright (overexposed) portions blink red in Standard Information Display or Histogram Display in playback mode.	Off	p.R26	
	Auto Image Rotation	Images are rotated when playing back images captured with the camera held vertically or images for which the rotation information has been changed.	On	p.R26	
	Protect All Images	Protects all images stored in the memory card at once.	–	p.R26	
	Delete All Images	Deletes all images stored in the memory card at once.	–	p.R27	

Menu	Item	Function	Default Setting	Page	
1	Language/言語	Changes the display language.	English	p.R28	
	Date Adjustment	Sets the date and time or display format.	01/01/2014	p.R28	
	World Time	Switches between the date and time display of your hometown city and that of a specified city.	Hometown	p.R28	
	Text Size	Sets whether to magnify the text size when selecting a menu.	Standard	p.R29	
	Sound Effects	Switches the operation sound on/off and changes the volume for In-focus, AE-L, Self-timer, Remote Control, Mirror Up, Change AF Point, and the RAW/Fx button.	Volume 3/ All On	p.R29	
	LCD Display	Guide Display	Sets whether to display the operation guides when the exposure mode is changed.	On	p.R30
		Auto Screen Rotation	Sets whether to display the status screen and control panel vertically if the camera is held vertically.	On	
		Display Color	Sets the display color of the status screen, control panel, and menu cursor.	1	
LCD Display Settings		Adjusts the brightness, saturation and the color of the monitor.	0	p.R30	
2	USB Connection	Sets the USB connection mode when connecting to a computer.	MSC	p.R30	
	HDMI Out	Sets the output format when connecting to an AV device with an HDMI input terminal.	Auto	p.R30	
	Folder Name	Sets the folder name in which images are stored.	Date	p.R31	
	Create New Folder	Creates a new folder on the memory card.	–	p.R32	
	File Name	Sets the file name assigned to an image.	IMGP/_IMG	p.R32	
	File No.	Sequential Numbering	Sets whether to continue the sequential numbering for the file name when a new folder is created.	On	p.R33
		Reset File Number	Resets the file number setting, and returns to 0001 each time a new folder is created.	–	
Copyright Information		Sets the photographer and copyright information embedded in Exif.	Off	p.R33	





Menu	Item	Function	Default Setting	Page
3	Flicker Reduction	Cuts down on the screen flicker by setting the power frequency.	50Hz	p.R34
	Auto Power Off	Sets the time until the camera turns off automatically if no operations are made for a certain period of time.	1min.	p.R34
	Wireless Memory Card	Sets the camera action for when an Eye-Fi card or a Flucard is used.	Auto/On	p.R34
	Reset	Resets the settings of the direct keys and for the items of the  menu,  menu,  menu,  menu, control panel, and playback mode palette.	–	p.R35
4	Pixel Mapping	Maps out and corrects any defective pixels on the CMOS sensor.	–	p.R35
	Dust Alert	Detects dust adhering to the CMOS sensor and visually displays the location of the dust on the monitor.	–	p.R36
	Dust Removal	Cleans the CMOS sensor by shaking it.	On	p.R37
	Sensor Cleaning	Locks the mirror in the up position for cleaning the CMOS sensor with a blower.	–	p.R37
	Format	Formats a memory card.	–	p.R38
	Firmware Info/Options	Displays the camera's firmware version.	–	p.R38

Menu	Item	Function	Default Setting	Page
C1	1. EV Steps	Sets the adjustment steps for exposure.	1/3 EV Steps	p.R39
	2. Sensitivity Steps	Sets the adjustment steps for ISO sensitivity.	1 EV Step	p.R39
	3. Meter Operating Time	Sets the meter operating time.	10sec.	p.R39
	4. AE-L with AF Locked	Sets whether to lock the exposure value when the focus is locked.	Off	p.R39
	5. Link AE and AF Point	Sets whether to link the exposure and AF point in the focusing area.	Off	p.R39
	6. Auto EV Compensation	Sets whether to automatically compensate when the proper exposure cannot be determined.	Off	p.R39
	7. Bulb (B) Mode Options	Sets the camera operation when pressing the shutter release button in B mode.	Type1	p.R39
C2	8. Bracketing Order	Sets the order for Exposure Bracketing shooting.	0 - +	p.R40
	9. One-Push Bracketing	Sets whether to shoot all frames with one release when using Exposure Bracketing.	Off	p.R40
	10. WB Adjustable Range	Sets whether to automatically fine-tune the white balance when the light source is specified for the white balance setting.	Fixed	p.R40
	11. WB When Using Flash	Sets the white balance setting for when using flash.	Auto White Balance	p.R40
	12. AWB in Tungsten Light	Sets the tungsten light color tone for when the white balance is set to [Auto White Balance].	Subtle Correction	p.R40
	13. Color Temperature Steps	Sets the adjustment steps for color temperature.	Kelvin	p.R40
	14. Superimpose AF Area	Sets whether to display the active AF point in red in the viewfinder.	On	p.R40













Menu	Item	Function	Default Setting	Page
C3	15. AF.S Setting	Sets the action priority for when the focus mode is set to AF.S and the shutter release button is fully pressed.	Focus-priority	p.R40
	16. 1st Frame Action in AF.C	Sets the action priority for the first frame when the focus mode is set to AF.C and the shutter release button is fully pressed.	Release-priority	p.R41
	17. Action in AF.C Continuous	Sets the action priority during continuous shooting when the focus mode is set to AF.C .	Focus-priority	p.R41
	18. Hold AF Status	Sets whether to maintain the focus for a certain amount of time when the subject happens to move out of the selected focusing area after being focused.	Off	p.R41
	19. AF with Remote Control	Sets whether to use autofocus when shooting with a remote control unit.	Off	p.R41
	20. Color Space	Sets the color space to use.	sRGB	p.R41
	21. LCD Panel Illumination	Sets the brightness of the LCD panel.	Low	p.R41
C4	22. Save Rotation Info	Sets whether to save rotation information when shooting.	On	p.R41
	23. Save Menu Location	The last menu tab displayed on the monitor is saved, and it is displayed again the next time MENU is pressed.	Reset Menu Location	p.R41
	24. AF Fine Adjustment	Allows you to precisely fine tune your lenses with the camera's autofocus system.	Off	p.R42
	25. Flash Sync Speed	Selects the flash sync speed.	1/125	p.R42
	26. 4-way Controller Options	Selects the ▲▼◀▶ operations for when the focusing area selection mode is set to one of the "Select" type modes.	Type1	p.R42
	27. Mirror Up Operation	Enables or disables the Mirror Up dial.	On	p.R42
	28. Shake Reduction Options	Select whether to perform Shake Reduction only when shooting or when the shutter release button is pressed halfway.	Type1	p.R43
C5	29. Enable/Disable Controls	Enables or disables operation of the selected group of buttons and dials using Lock .	Type1	p.R43
	Reset Custom Functions	Resets all the settings of the Custom Setting menu to the defaults.	–	p.R43

Other Default Settings

Direct Keys

Item	Default Setting	Page
Flash Mode	Flash On	 p.64
Custom Image	Natural	 p.68
Drive Mode	Single Frame Shooting	 p.56
White Balance	Auto White Balance	 p.53

Playback Mode Palette

Item	Default Setting	Page
Image Rotation	-	 p.76
Digital Filter	Base Parameter Adj	 p.79
Color Moiré Correction	-	 p.78
Resize	Maximum size according to the setting	 p.77
Cropping	Maximum size according to the setting	 p.78
Protect	-	 p.83
Slideshow	-	 p.76
Save as Manual WB	-	 p.54
Save Cross Processing	-	 p.69
RAW Development	File Format: JPEG JPEG Recorded Pixels: <input type="checkbox"/> JPEG Quality: ★★★	 p.82
Movie Edit	-	 p.81
Image Copy	-	 p.77
Eye-Fi Image Transfer	-	p.R34

How to Use the Menu

Example: when setting [Slow Shutter Speed NR]

Menu Descriptions and Default Settings

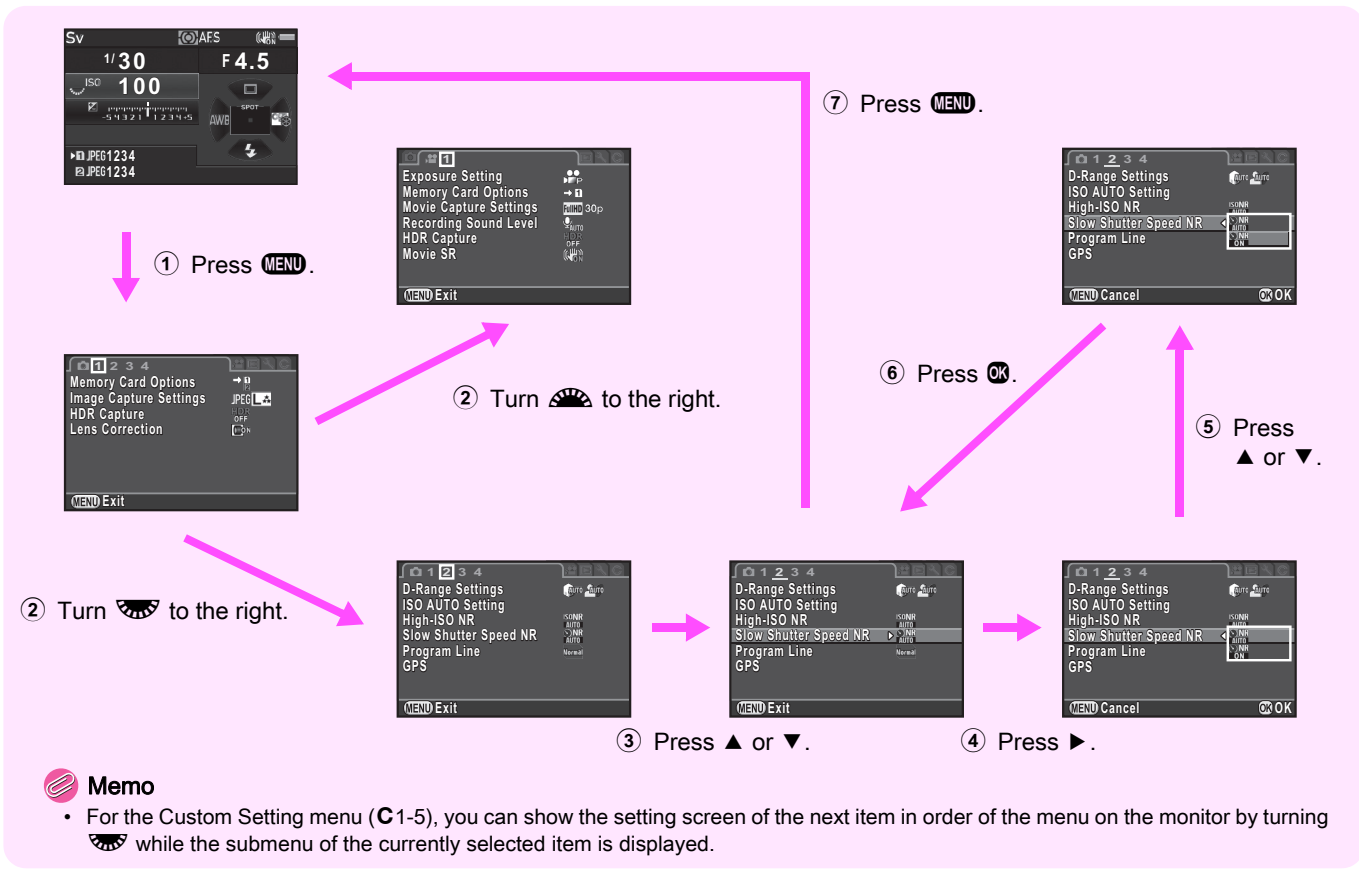

Rec. Mode Menu

Memo

- Functions with the control panel icon  next to the menu icon and number in the right end of the title bar can also be set from the control panel.

Exposure Mode



Switches between the exposure modes temporarily when the mode dial is set to **U1**, **U2** or **U3**.

Memo

- When the camera is turned off, the exposure mode set here reverts to the previously-saved one.
- Refer to “Save USER Mode” (p.R22) for saving the desired settings to **U1**, **U2** and **U3**.

Memory Card Options

Sets the recording method for when two memory cards are inserted.

 Sequential Use	When the memory card in SD1 slot becomes full, data is saved to the card in SD2.
 Save to Both	Saves the same data to the memory cards in both SD1 and SD2.
 Separate RAW/JPEG	Saves the RAW data to the memory card in SD1, and JPEG data to the card in SD2.

Memo



- When in  mode, data is saved to the card in either SD1 or SD2. It can be set in the 1 menu. (p.R24)

Image Capture Settings

Sets the file format for still pictures.

File Format	JPEG, RAW, RAW+, TIFF
JPEG Recorded Pixels	<input type="checkbox"/> L, <input type="checkbox"/> M, <input type="checkbox"/> S, <input type="checkbox"/> XS
JPEG Quality	★★★, ★★, ★
RAW File Format	PEF, DNG
180° Rotation Info	<input type="checkbox"/> , <input checked="" type="checkbox"/>

Caution

- When [Memory Card Options] of the 1 menu is set to [Separate RAW/JPEG], [File Format] is fixed to [RAW+].

Memo

- When [File Format] is set to [RAW+], a JPEG image and a RAW image with the same file number are saved at the same time.
- You can take pictures with a different file format setting only when **RAW** is pressed. (p.R21)
- [PEF] of [RAW File Format] is a PENTAX original RAW file format.
- When [180° Rotation Info] is set to on,  appears on the status screen and Live View screen.

● Number of recorded pixels and pixel resolution for JPEG files

	Recorded Pixels	Pixels
<input type="checkbox"/> L	51M	8256×6192
<input type="checkbox"/> M	36M	6912×5184
<input type="checkbox"/> S	21M	5376×4032
<input type="checkbox"/> XS	3M	1920×1440



HDR Capture



Takes three consecutive images at three different exposure levels to create a single composite picture with them.

1 Select [HDR Capture] in 1 menu and press **▶**.

The [HDR Capture] screen appears.

2 Select [HDR AUTO], [HDR 1], [HDR 2] or [HDR 3], and press **OK**.

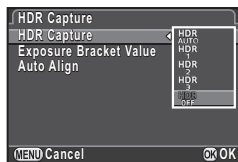

3 Set the range in which to change the exposure in [Exposure Bracket Value].

Select from ± 1 , ± 2 , or ± 3 .

4 Set whether to use Auto Align or not.

<input checked="" type="checkbox"/>	Uses Auto Align.
<input type="checkbox"/>	Does not use Auto Align. The Shake Reduction function on the lens is disabled.

5 Press **MENU** twice.

The camera returns to standby mode.

Caution

- HDR Capture is not available in **B** or **X** mode.
- This function cannot be used in combination with some other functions. (p.R44)
- When the drive mode is set to [Interval Shooting], [Auto Align] is fixed to off.
- For HDR Capture, multiple images are combined together to create a single image, so it will take time to save the image.

Lens Correction



The following features are available.

Distortion Correction	Reduces distortions occurring due to lens properties.
Lat-Chromatic-Ab Adj	Reduces lateral chromatic aberrations occurring due to lens properties.
Peripheral Illumin. Corr.	Reduces peripheral light fall-off occurring due to lens properties.
Diffraction Correction	Corrects the diffraction when the aperture is small.

Memo

- Corrections can only be made when a D FA645 or FA645 lens is attached to the camera. (p.28) The features are disabled when using an accessory such as a rear converter that is attached between the camera and the lens.
- For RAW images, correction information is saved as a RAW file parameter and you can select whether to apply the correction to the images when developing them. For the RAW Development function, [Color Fringe Correction] can also be set. (p.82)

D-Range Settings



Expands the dynamic range and enables a wider range of tones by the CMOS sensor and reduces the occurrence of overexposed/underexposed areas. Set [Highlight Correction] to [AUTO], [ON], or [OFF], and set [Shadow Correction] to [AUTO], [Low], [Medium], [High] or [OFF].

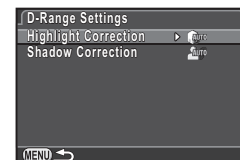

ISO AUTO Setting



Sets the range in which the sensitivity is automatically adjusted when the sensitivity is set to ISO AUTO. The manner in which the sensitivity is increased can be specified in [AUTO ISO Parameters].

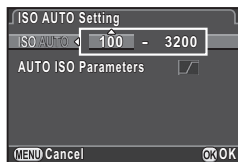

<input type="checkbox"/> Slow	Increases the sensitivity as little as possible.
<input checked="" type="checkbox"/> Standard	(Default setting)
<input checked="" type="checkbox"/> Fast	Actively increases the sensitivity.

Memo

- When [HDR Capture] of the 1 menu is set and [Auto Align] is set to on, [AUTO ISO Parameters] is fixed to **Fast**.

High-ISO NR



Sets the Noise Reduction setting when shooting with a high ISO sensitivity.

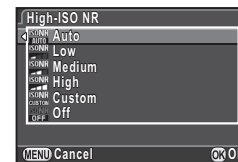

Auto	Applies Noise Reduction at optimally calculated levels throughout ISO range.
Low/ Medium/ High	Applies Noise Reduction at constant chosen level throughout ISO range.
Custom	Applies Noise Reduction at user-defined levels for each ISO setting.
Off	Does not apply Noise Reduction at any ISO setting.

When [Custom] is selected, select [Setting] and set the noise reduction level according to the ISO sensitivity.

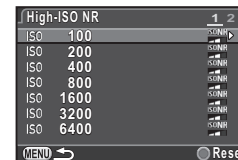

Slow Shutter Speed NR



Sets how the Noise Reduction function works during long exposures.

AUTO	The camera determines the camera conditions, such as the shutter speed, sensitivity, and internal temperature, and reduces noise as necessary.
ON	Reduces noise at shutter speed of 1 second or slower.



Program Line



In [E-Dial Programming] of the menu, you can specify how exposure is controlled when [P LINE] is selected (p.R20) for the button operation.

	Auto	The camera determines the appropriate settings.
	Normal	Basic program automatic exposure.
	Hi-speed priority	Prioritizes high shutter speeds.
	DOF priority (deep)	Closes the aperture for a deep depth of field.
	DOF priority (shallow)	Opens the aperture for a shallow depth of field.
	MTF priority	Prioritizes the optimum aperture setting of the attached lens when a A645, FA645, or D FA645 lens is used.

GPS



The following functions are available when the optional GPS unit O-GPS1 is attached to this camera.

Electronic Compass	Displays the current latitude, longitude, altitude, direction, and Coordinated Universal Time (UTC).	
GPS Time Sync	Automatically adjusts the camera's date and time settings using information acquired from GPS satellites.	

Memo

- Refer to the manual of the GPS unit for details on how to attach the unit and information on the unit's functions.
- To display [Electronic Compass], refer to "Shooting Info Display" (p.18).

Caution

- Simple Navigation and ASTROTRACER cannot be used with this camera.

Live View



Sets the focus settings and display settings for shooting with Live View.

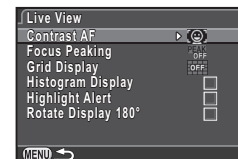

Contrast AF

You can select an autofocus mode when shooting with Live View. The setting can also be changed by turning while pressing during Live View. (p.46)

Focus Peaking

When [Focus Peaking] is set to on, the outline of the subject in focus is emphasized and makes it easier to check the focus. This function works in both **AF** and **MF** modes.

Other Display Settings

Grid Display	Grid Style	4×4, Golden Section, Scale, Square 1, Square 2, OFF
	Grid Color	Translucent black color, Translucent white color
Histogram Display		Displays the histogram.
Highlight Alert		Bright (overexposed) areas blink red.
Rotate Display 180°		Displays the Live View image rotated 180°.

Memo

- Even if [Rotate Display 180°] is set to on, the original, unrotated version of the image is saved. To save the rotated image, set [180° Rotation Info] in [Image Capture Settings] of the 1 menu. (p.R15)



Electronic Level

Sets whether to display the electronic level in the viewfinder and/or on the monitor during Live View.

Viewfinder	The horizontal tilt is displayed on the EV bar scale in the viewfinder and on the LCD panel in increments of 0.5° (up to 4.5°).
Live View	On the Live View screen, the horizontal tilt is displayed at the top of the screen and the vertical tilt on right side of the screen, both in increments of 0.5° (up to 9.5°).



Instant Review

Sets the operation and display settings during Instant Review. The following settings are available.

Display Time	Selects the Instant Review display time from [1sec.], [3sec.], [5sec.], [HOLD] and [Off]. When [HOLD] is selected, Instant Review will be displayed until the next operation.
Zoom Instant Review	Sets whether to magnify the image using  .
Save RAW Data	Sets whether to save the RAW image using  when the data is available.
Delete	Deletes the image when  is pressed.
Histogram Display	Displays the histogram.
Highlight Alert	Sets bright (overexposed) areas to blink red.

Digital Preview

Sets the operation and display settings during Digital Preview.

Zoom Instant Review	Sets whether to magnify the image using  .
Save Preview Image	Sets whether to save the preview image using  .
Histogram Display	Displays the histogram.
Highlight Alert	Sets bright (overexposed) areas to blink red.

Memo

- Refer to the “Operating Manual” for details on preview operations. ( p.67)

E-Dial Programming



For each exposure mode, you can select the parameters for when and are turned and is pressed.

- 1 Select [E-Dial Programming] in 4 menu and press .

The [E-Dial Programming] screen appears.

- 2 Select an exposure mode and press .

The screen for the selected exposure mode appears.

- 3 Select the desired setting for each exposure mode and press .

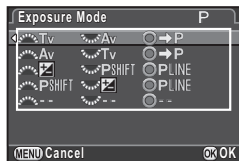

Tv	Change Shutter Speed
Av	Change Aperture Value
ISO	Change Sensitivity
	EV Compensation
	Return to P Mode
PSHIFT	Program Shift
PLINE	Program Line
--	Not available

- 4 Press .

The [E-Dial Programming] screen reappears.
Repeat Steps 2 to 4.

- 5 Press twice.

Memo

- If you select [Rotation Direction] in Step 2, you can reverse the effect obtained by turning or .

Button Customization



You can set the functions for when , or is pressed, or when the main switch is turned to .

- 1 Select [Button Customization] in 4 menu and press .

The [Button Customization] screen appears.

- 2 Select the item to set and press .

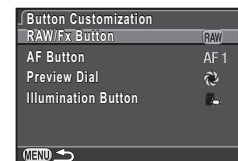

The screen to set the function for the selected item is displayed.



- 3 Select a function and press .

The following functions can be assigned to each button.

	Setting	Function	Page
RAW/Fx Button	One Push File Format	Temporarily changes the file format.	p.R21
	Optical Preview	Activates the Optical Preview.	p.67
	Digital Preview	Activates the Digital Preview.	
AF Button	Enable AF1	Autofocus is performed when is pressed.	p.44
	Enable AF2	Autofocus is performed when is pressed and not when the shutter release button is pressed halfway.	
	Cancel AF	While is pressed, autofocus is not performed even when the shutter release button is pressed halfway.	

	Setting	Function	Page
Preview Dial	Optical Preview	Activates the Optical Preview.	📖 p.67
	Digital Preview	Activates the Digital Preview.	
Illumination Button	LCD Panel Illumination	Turns the LCD panel illumination on when  is pressed.	📖 p.23
	Modeling Flash	Discharges the flash in Modeling Flash mode when a flash is connected and  is pressed.	
	Test Flash	Discharges the flash in Test Flash mode when a flash is connected and  is pressed.	

4 Press **MENU**.

The [Button Customization] screen reappears.
Repeat Steps 2 to 4.

5 Press **MENU** twice.

One Push File Format

- 1 Set [RAW/Fx Button] to [One Push File Format] in Step 3 of "Button Customization" (p.R20).
- 2 Select or for [Cancel after 1 shot].

<input checked="" type="checkbox"/>	The recording format returns to the [File Format] setting of [Image Capture Settings] in the  1 menu after a picture is taken.
<input type="checkbox"/>	The setting is retained until any of the following operations is performed: <ul style="list-style-type: none"> • When RAW is pressed again • When Q, MENU or INFO is pressed, or when the mode dial or main switch is turned

3 Select the file format when **RAW** is pressed.

The left side is the [File Format] setting and the right side is the changed file format when **RAW** is pressed.

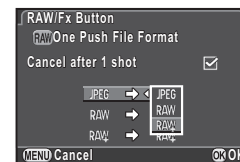

Caution

- The One Push File Format function cannot be used when [Memory Card Options] is set to [Separate RAW/JPEG] in the  1 menu. (p.R15)



Memory



Most of the functions set on this camera are saved even if the camera is turned off. For the following function settings, you can select whether to save the settings (☑) or to return the settings to their default values (☐) when the camera is turned off.

- | | |
|-------------------|-------------------------------|
| • Flash Mode | • Flash Exposure Compensation |
| • Drive Mode | • Exposure Bracketing |
| • White Balance | • HDR Capture |
| • Custom Image | • Playback Info Display |
| • Sensitivity | • Enable/Disable Controls |
| • EV Compensation | |

⚠ Caution

- [Memory] cannot be selected when the mode dial is set to **U1**, **U2**, or **U3**.

📝 Memo



- If [Playback Info Display] is set to off, the [Standard Information Display] always appears first when the camera is turned on. (📖 p.19)
- When [Reset] of the **3** menu is performed, all Memory settings return to the default values. (p.R35)

Save USER Mode



Camera settings can be saved to **U1**, **U2**, and **U3** of the mode dial and used repeatedly.

The following settings can be saved.

- | | |
|---|---|
| • Exposure Mode (except for ) | • Drive Mode |
| • Sensitivity | • White Balance |
| • EV Compensation | • Custom Image |
| • Metering mode | •  1-4 menu settings (with exceptions) |
| • AF point | • C 1-5 menu settings (with exceptions) |
| • Flash Mode | |

Save Settings

- 1** Set all of the settings to save on the camera.
- 2** Select [Save USER Mode] in  4 menu and press **▶**.
The [Save USER Mode] screen appears.
- 3** Select [Save Settings] and press **▶**.
The [Save Settings] screen appears.



- 4** Select [USER1], [USER2] or [USER3], and press **▶**.
- 5** Select [Save] and press **OK**.
The [Save Settings] screen reappears.

Memo

- The settings saved as the USER mode can be displayed on the monitor when you select [Check Saved Settings] in Step 3.
- To reset the settings to the default values, select [Reset USER Mode] in Step 3.

Rename USER Mode

You can change the name of the USER mode in which you saved settings.

1 Select [Rename USER Mode] in Step 3 of “Save Settings” and press ►.

The [Rename USER Mode] screen appears.

2 Select [USER1], [USER2] or [USER3], and press ►.

The text-entry screen appears.

3 Change the text.



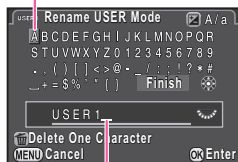

Up to 18 single-byte alphanumeric characters and symbols can be entered.

Text selection cursor



Available operations

Text input cursor

	Moves the text selection cursor.
	Moves the text input cursor.
	Switches between upper and lower case letters.
	Enters a character selected with the text selection cursor at the position of the text input cursor.
	Deletes a character at the position of the text input cursor.

4 After entering the text, move the text selection cursor to [Finish], and press OK.

The [Rename USER Mode] screen reappears.

Using the Saved USER Mode

1 Set the mode dial to U1, U2 or U3.

The USER mode guide is displayed for 30 seconds.

Use ▲▼ to check the saved settings.



2 Change the settings as necessary.

The exposure mode can be changed in [Exposure Mode] of the  1 menu.

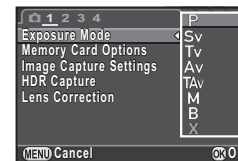

Memo

- The settings changed in Step 2 are not saved as the USER mode settings. When the camera is turned off, the settings return to the originally saved ones. To change the original settings, save the USER mode settings again.







Movie Menu

Memo

- Functions with the control panel icon  next to the menu icon and number in the right end of the title bar can also be set from the control panel.

Exposure Setting

Selects the exposure mode for  mode from , , , or .

Memory Card Options



Selects one of memory cards inserted in SD1 and SD2 slots for recording movies.

Caution

- When in  mode, data is saved only to the memory card in the selected slot. You cannot record movies when the memory card in the selected slot is full.

Movie Capture Settings

Sets the file format for movies.

Recorded Pixels	Framerate
	60i, 50i, 30p, 25p, 24p
	60p, 50p, 30p, 25p, 24p

Recording Sound Level

Select from [Auto], [Manual], or [Mute] for the movie recording volume. When [Manual] is selected, set the volume from 0 to 20.

Memo

- When [Manual] is set, a bar graph indicating the microphone volume level appears on the both sides of the Live View screen.

HDR Capture

High dynamic range shooting is available when the drive mode is set to [Interval Movie Record] ( p.61).

1 Select [HDR Capture] in  1 menu and press .

The [HDR Capture] screen appears.

2 Select [HDR AUTO], [HDR 1], [HDR 2] or [HDR 3], and press .

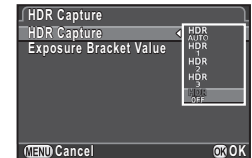

3 Set the range in which to change the exposure in [Exposure Bracket Value].

Select from ± 1 , ± 2 , or ± 3 .

4 Press  twice.

The camera returns to standby mode.

 **Caution**

- When the drive mode is not set to [Interval Movie Record], this function is not available.

Movie SR



Activates the Movie Shake Reduction function.



▶ Playback Menu

Slideshow



Select the memory card in either the SD1 or SD2 slot, and set how to display images during slideshow. Select [Start] to start slideshow playback.

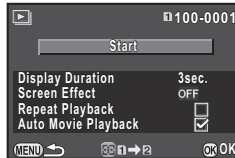

Item	Description	Setting
Display Duration	Sets an image display interval.	3sec., 5sec., 10sec., 30sec.
Screen Effect	Sets a transition effect when the next image is displayed	Fade, Wipe, Stripe, OFF
Repeat Playback	Sets whether the slideshow will start again from the beginning after the last image is displayed.	<input type="checkbox"/> , <input checked="" type="checkbox"/>
Auto Movie Playback	Plays back movies during the slideshow.	<input checked="" type="checkbox"/> , <input type="checkbox"/>

Press (**1/2**) to switch between the memory cards inserted in the two slots, SD1 and SD2.

📌 Memo

- Refer to the “Operating Manual” for details on operations during slideshow playback. (p.76)

Quick Zoom



Sets the initial magnification when magnifying images (p.73). Select from (actual pixel size), [**×16**], [**×8**], [**×4**], [**×2**], and [Off].

Grid Display



You can display the grid in [Standard Information Display] or [No Information Display] in playback mode. Select from the following grid styles and colors.

Grid Style	4×4, Golden Section, Scale, Square 1, Square 2, OFF
Grid Color	Translucent black color, translucent white color

📌 Memo

- The grid cannot be displayed while viewing a movie, displaying a magnified image, or vertically displaying an image with its size reduced.

Highlight Alert



Bright (overexposed) portions blink red in Standard Information Display, Histogram Display, or No Information Display in playback mode.

Auto Image Rotation



Images are rotated and displayed according to the orientation of the camera when playing back images captured with the camera held vertically or images for which the rotation information has been changed.

Protect All Images



You can select the memory card in the SD1 or SD2 slot and protect all saved images at once. Select [Unprotect] to remove protection from all images.



Delete All Images



You can select the memory card in the SD1 or SD2 slot and delete all saved images at once.

When there are images with protection set, select [Delete all] or [Leave all].



Set-up Menu

Language/言語

You can change the language in which the menus, error messages, etc. are displayed.

Date Adjustment

You can change the date and time set at the initial setting ( p.35). You can also set the display format.

Display Format	
Date	mm/dd/yy, dd/mm/yy, yy/mm/dd
Time	12h, 24h

World Time

The date and time set at the initial setting ( p.34) serve as the date and time of your present location and are reflected in the shooting date and time for images.

Setting the destination to a location other than your present location enables you to display the local date and time on the monitor when traveling abroad and also save images time-stamped with the local date and time.

You can select from following cities for the hometown and destination.

Region	City
North America	Honolulu, Anchorage, Vancouver, San Francisco, Los Angeles, Calgary, Denver, Chicago, Miami, Toronto, New York, Halifax
Central and South America	Mexico City, Lima, Santiago, Caracas, Buenos Aires, Sao Paulo, Rio de Janeiro
Europe	Lisbon, Madrid, London, Paris, Amsterdam, Milan, Rome, Copenhagen, Berlin, Prague, Stockholm, Budapest, Warsaw, Athens, Helsinki, Moscow
Africa/ West Asia	Dakar, Algiers, Johannesburg, Istanbul, Cairo, Jerusalem, Nairobi, Jeddah, Tehran, Dubai, Karachi, Kabul, Male, Delhi, Colombo, Kathmandu, Dacca
East Asia	Yangon, Bangkok, Kuala Lumpur, Vientiane, Singapore, Phnom Penh, Ho chi Minh, Jakarta, Hong Kong, Beijing, Shanghai, Manila, Taipei, Seoul, Tokyo, Guam
Oceania	Perth, Adelaide, Sydney, Noumea, Wellington, Auckland, Pago Pago

1 Select [World Time] in 1 menu.

The [World Time] screen appears.

2 Select the time you wish to display in [Time Setting].

Select (Hometown) or (Destination).

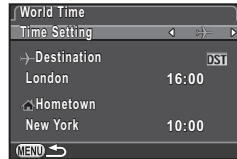

3 Select [Destination] and press .

The [Destination] screen appears.

4 Use to select a city.

Use to change the region.

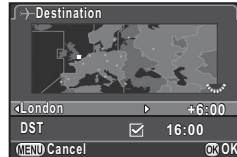

5 Select [DST] (daylight saving time), and use to select or .

6 Press .

The [World Time] screen reappears.

7 Press twice.

Memo

- Select [Hometown] in Step 3 to change the city and DST settings for the hometown.
- and the local date and time appear in the control panel when [Time Setting] is set to .

Text Size



You can set the size of the text that appears on the menu screens to [Standard] (normal display) or [Large] (magnified display).

When set to [Large], the character string on which the menu cursor is placed is magnified approximately 1.5 times vertically.

Sound Effects



You can set the volume of the sound effects and whether the sound effects are emitted during the following operations.

- In-focus
- AE Lock
- During [Self-timer] countdown in drive mode
- During [Remote Control] countdown in drive mode
- When the camera is ready to shoot with the mirror raised
- When the function of the arrow keys () is switched by pressing
- When operating One Push File Format with

Memo

- You can turn all the sound effects off by setting for [Volume].



LCD Display



Sets the general display settings for the LCD display. The following settings are available.

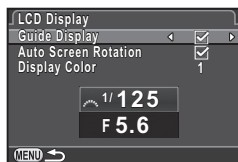

Guide Display	Displays the operation guides when the exposure mode is changed.
Auto Screen Rotation	Displays the status screen and control panel vertically if the camera is held vertically.
Display Color	Sets the display color of the status screen, control panel and menu cursor.

LCD Display Settings



Adjusts the brightness, saturation and the color of the monitor (B-A, G-M).



Available operations

▲▼	Selects an item.
◀▶	Adjusts the value (15 levels for each item).
○	Resets the adjustment value.
☀	Displays a captured image in the background so you can adjust the color while viewing the image.

USB Connection



Set the USB connection mode (MSC or PTP) when connecting this camera to a computer via a commercially available USB cable.

Memo

- Refer to the “Operating Manual” to connect the camera to a computer. (📖 p.87)

HDMI Out



Set the output format of the HDMI terminal.

Auto	The maximum resolution supported by the AV device and camera is automatically selected.
1080i	1920×1080i
720p	1280×720p
576p	1280×576p
480p	720×480p

Memo

- When the HDMI output format is set to [1080i] or [720p], the display may appear with a screen design that differs from that of the camera.

Folder Name



When images are captured with this camera, a folder is automatically created and the captured images are stored in it. Each folder name consists of a sequential number from 100 to 999 and a string of 5 characters. The character string for the folder name can be changed.

1 Select [Folder Name] in 2 menu and press .

The [Folder Name] screen appears.

2 Select a folder name and press .

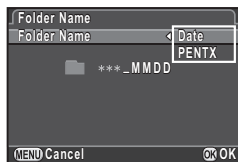

Date	The two digits of the month and day on which the picture was taken are assigned after the folder number. [MMDD] appears according to the date format set in [Date Adjustment]. Example) 101_0125: for images taken on January 25th
PENTX	The character string "PENTX" is assigned after the folder number. Example) 101PENTX

Proceed to Step 5 if you do not need to change the folder name.

3 Press , and then press .

The text-entry screen appears.

4 Change the text.





Enter 5 single-byte alphanumeric characters.

Text selection cursor



Text input cursor

Available operations

-  Moves the text selection cursor.
-  Moves the text input cursor.
-  Enters a character selected with the text selection cursor at the position of the text input cursor.
-  Resets the adjustment value to the default setting.

5 After entering the text, move the text selection cursor to [Finish] and press .

6 Press twice.

Memo

- A folder with a new number is created when the folder name is changed.
- A maximum of 500 images (100 images for Eye-Fi card) can be stored in a single folder. When the number of captured images exceeds 500, a new folder is created with the number following the number of the folder currently being used. In Exposure Bracketing shooting, images will be stored in the same folder until shooting is completed.
- When [Select multiple images] or [Select a folder] of [RAW Development] is selected, a folder with a new number is created, and the JPEG images are stored in it.



⚠ Caution

- The maximum folder number is 999. After the folder number reaches 999, you cannot capture new images if you attempt to change the folder name or create a new folder, or when the file name number reaches 9999.

Create New Folder



A folder is created with a new number when the next image is saved. When a memory card is inserted in both SD1 and SD2 slots, a new folder is created on both memory cards.

File Name



One of the following string of characters is used as the file name prefix depending on the [20. Color Space] (p.R41) setting of the **C3** menu.

Color Space	File Name
sRGB	IMGPxxxx.JPG
AdobeRGB	_IMGxxxx.JPG

The first four characters can be changed to a character string of your choice.

1 Select [File Name] in menu and press **▶**.

The [File Name] screen appears.

2 Select or and press **▶**.

The text-entry screen appears.



3 Change the text.

Up to 4 single-byte alphanumeric characters can be entered.

Text selection cursor



Text input cursor

Available operations

	Moves the text selection cursor.
	Moves the text input cursor.
	Enters a character selected with the text selection cursor at the position of the text input cursor.
	Resets the adjustment value to the default setting.

4 After entering the text, move the text selection cursor to [Finish] and press **OK**.

5 Press **MENU** twice.

📌 Memo

- When [Color Space] is set to [AdobeRGB], the file name prefix is “_” and first three characters of the entered character string becomes the file name.
- For movies, regardless of the [Color Space] setting, the file name is “IMGPxxxx.MOV” or a file name with the entered string of characters.

⚠ Caution

- “INDX” cannot be used as the character string for the file name.

File No.



Each file name consists of a string of 4 characters and a sequential number from 0001 to 9999.

In [Sequential Numbering], you can set whether to continue the sequential numbering for the file name when a new folder is created.

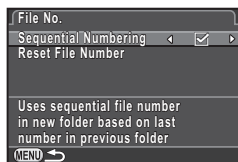

<input checked="" type="checkbox"/>	Continues the sequential numbering for the file name even if a new folder is created.
<input type="checkbox"/>	Returns the file number of the first image saved to a folder to 0001 each time a new folder is created.

Select [Reset File Number] to reset the file number to its default value.

Memo

- When the file number reaches 9999, a new folder is created and the file number is reset.

Copyright Information



Sets the photographer and copyright information embedded in Exif data.

1 Select [Copyright Information] in menu and press **▶**.

The [Copyright Information] screen appears.

2 Use **◀▶** to set [Embed Copyright Data].

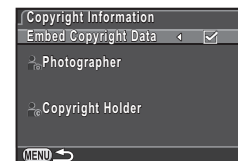

<input type="checkbox"/>	Does not embed copyright information in the Exif.
<input checked="" type="checkbox"/>	Embeds copyright information in the Exif.

3 Select [Photographer] or [Copyright Holder], and press **▶**.

The text-entry screen appears.

4 Change the text.

Up to 32 single-byte alphanumeric characters and symbols can be entered.

Text selection cursor

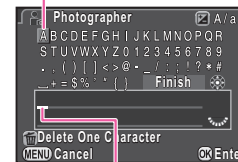

Text input cursor



Available operations

▲▼▶◀	Moves the text selection cursor.
☺	Moves the text input cursor.
Ⓜ	Switches between upper and lower case letters.
Ⓚ	Enters a character selected with the text selection cursor at the position of the text input cursor.
Ⓜ	Deletes a character at the position of the text input cursor.

5 After entering the text, move the text selection cursor to [Finish] and press **Ⓚ**.

6 Press **MENU** twice.

Memo

- The Exif information can be checked using the provided software “Digital Camera Utility 5”. (📖 p.88)
- When [Embed Copyright Data] is set to on, a copyright symbol (©) appears on the status screen and LCD panel.

Flicker Reduction

You can set the power frequency (50Hz, 60Hz) to that used in the region. The camera controls the exposure and cuts down on the screen flicker based on the selected power frequency.

Auto Power Off

You can set the camera to turn off automatically if unused for a set period of time. Select from [1min.], [3min.], [5min.], [10min.], [30min.] or [Off].

Memo

- The Auto Power Off function does not work during slideshow playback, when connected to a computer with a USB cable, or when transferring images using an Eye-Fi card.

Wireless Memory Card

A memory card with a built-in wireless LAN “Eye-Fi card” (Wi-Fi transmission) or a “Flucard” compatible with this camera can be used. By using these cards, images can be transferred from the camera to a computer or other device via wireless LAN. Sets the camera action for when an Eye-Fi card or a Flucard is used.

1 Select [Wireless Memory Card] in  menu and press **▶**.

The [Wireless Memory Card] screen appears.

2 Select [Action Mode].

Items that can be set are displayed according to the type of card inserted.

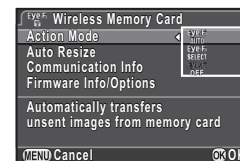

Eye-Fi card

AUTO	Transfers images automatically when there are any images that have not yet been transferred. For movies, only files under 2 GB can be transferred.
SELECT	Transfers images or a folder that are selected in [Eye-Fi Image Transfer] of the playback mode palette. Movies cannot be transferred.
OFF	Stops the communication function.

Flucard



ON	Enables wireless data transfer with Flucard.
OFF	Disables wireless data transfer with Flucard.

3 Specify [Auto Resize].

When set to , JPEG images are saved to the Eye-Fi card or Flucard at the size of .

4 Press twice.





Caution

- Be sure to insert an Eye-Fi card or a Flucard in the SD2 slot. If it is inserted in the SD1 slot, the wireless LAN function cannot be used. When an Eye-Fi card or a Flucard is not inserted in the SD2 slot, the [Wireless Memory Card] settings of the  3 menu cannot be set.
- Set up a wireless LAN access point on a computer for the card connection.
- For RAW images, the success of transfer depends on the specifications and settings of the Eye-Fi card in use.
- Images may not be transferred when the battery level is low.
- It may take time to transfer a large number of images. The camera may turn off if the internal temperature of the camera becomes high.
- For precautions on the Eye-Fi card, refer to “About Eye-Fi Cards” ( p.5).

Memo

- A communication terminal, such as a smartphone or tablet, can be used to operate this camera when a Flucard compatible with this camera is inserted. Refer to the Flucard manual for details on how to use the card.
- When an Eye-Fi card is used, 100 images can be stored in a single folder. For RAW+ images, two files are counted as one image.
- In Step 2, select [Communication Info] to check the Wireless LAN information, and [Firmware Info/Options] to check the firmware version of the cards.
- When [Reset Transfer Settings] is selected in Step 2, the [Action Mode] setting is returned to their default values.



Reset

Resets the settings of the direct keys and for the items of the  menu,  menu,  menu,  menu, control panel, and playback mode palette.

Caution

- The Reset function is not available when the mode dial is set to **U1**, **U2** or **U3**.

Memo

- The following functions are not reset.
 - [Save USER Mode] in the  4 menu
 - [Language/言語], [Date Adjustment], city and DST settings for [World Time], [Text Size], [Copyright Information] and [Flicker Reduction] in the  3 menu
 - **C** menu

Pixel Mapping

This maps out and corrects defective pixels in the CMOS sensor.

Caution

- Pixel Mapping cannot be performed when the battery level is low. Use the optional AC adapter kit or load a fully charged battery.



Dust Alert is the function that detects dust adhering to the CMOS sensor and visually displays the location of the dust. You can save the detected image and display it when performing Sensor Cleaning of the  4 menu. (p.R37) Make sure that the camera is in the following status.

- Attach a D FA645 or FA645 (**A** aperture position) lens.
- Set the focus mode on the lens to **AF**.
- Turn the Stills/Movie switching dial to .

1 Select [Dust Alert] in 4 menu and press .

The [Dust Alert] screen appears.

2 Fully display a white wall or other bright subject with no detail in the viewfinder and press the shutter release button fully.

After image processing is performed, the Dust Alert image appears.

If [The operation could not be completed correctly] appears, press **OK** and take another picture.

3 Check the sensor for dust.

Use  to display the Dust Alert image at full screen display.

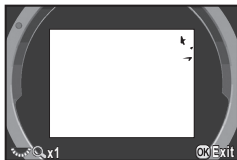

4 Press **OK**.

The Dust Alert image is saved and the  4 menu reappears.

Caution

- The exposure time may be long when using the Dust Alert function. Note that if the lens direction changes before processing is complete, dust will not be detected properly.
- Depending on the subject conditions or temperature, dust may not be detected properly.
- The Dust Alert function cannot be used when the shutter is locked.
- The Dust Alert image can only be displayed during sensor cleaning within 30 minutes after the image is saved. If more than 30 minutes elapse, save a new Dust Alert image and then perform sensor cleaning.
- The saved Dust Alert image cannot be displayed in playback mode.

Memo

- Regardless of the camera settings, the Dust Alert image will be taken with specific shooting settings.
- Only the latest Dust Alert image is saved to the SD1 slot memory card for approximately 30 minutes. If the sensor cleaning is performed during this time, the Dust Alert image can be checked while cleaning the sensor. If recording to the SD1 slot memory card is not possible, the image is not saved.

Dust Removal





This removes dust adhering to the CMOS sensor by applying ultrasonic vibrations to the filter on the front surface of the sensor for approximately one second. Set [Startup Action] and [Shutdown Action] to to turn the Dust Removal function on every time the camera is turned on/off.

Sensor Cleaning



Raise the mirror up and open the shutter to clean with a blower. If you use the Dust Alert function to detect dust on the sensor within 30 minutes before the sensor cleaning, the Dust Alert image appears on the monitor to enable you to check the location of dust.

- 1 Turn the camera off and remove the lens.**
- 2 Turn the camera on.**
- 3 Select [Sensor Cleaning] in 4 menu and press .**
The [Sensor Cleaning] screen appears.
- 4 Select [Mirror Up] and press .**
The mirror rises up.
The self-timer lamp blinks and [Cln] appears on the LCD panel. If a Dust Alert image is saved, it appears.
- 5 Clean the CMOS sensor with a blower.**
- 6 Turn the camera off.**
The mirror automatically returns to its original position.

Caution

- Never use a spray blower or a blower with a brush. The CMOS sensor may be damaged. Do not wipe the CMOS sensor with a cloth.
- Do not put the tip of the blower inside the lens mount area. If the power is turned off, this may cause damage to the shutter, CMOS sensor and the mirror.
- When the battery level is low, the message [Not enough battery power remaining to clean sensor] is displayed on the monitor. Install a fully charged battery. If the battery capacity becomes low during cleaning, a warning beep will sound. In this case, stop cleaning immediately.

Memo

- Please contact your nearest service center for professional cleaning as the CMOS sensor is a precision part.
- You can use the optional Imagesensor Cleaning kit O-ICK1 when cleaning the CMOS sensor.



Format



Select the memory card in either the SD1 or SD2 slot and format it. (📖 p.36)

⚠ Caution

- Do not remove the memory card while formatting. The card may be damaged.
- Formatting deletes all data, both protected and unprotected.

📌 Memo

- When a memory card is formatted, the volume label "645Z" is assigned to the card. When the camera is connected to a computer, the memory card is recognized as a removable disk with the name "645Z".

Firmware Info/Options



Displays the camera's firmware version.

C Custom Setting Menu

1. EV Steps

C1

Sets the step interval for exposure.

Setting	Exposure Setting Value
1/3 EV Steps	±0.3, ±0.7, ±1.0, ±1.3, ±1.7, ±2.0, ±2.3, ±2.7, ±3.0, ±3.3, ±3.7, ±4.0, ±4.3, ±4.7, ±5.0
1/2 EV Steps	±0.5, ±1.0, ±1.5, ±2.0, ±2.5, ±3.0, ±3.5, ±4.0, ±4.5, ±5.0

2. Sensitivity Steps

C1

Sets whether to adjust the sensitivity in increments of 1 EV step or in accordance with the [EV Steps] setting for exposure.

3. Meter Operating Time

C1

Select from [10sec.], [20sec.], [30sec.] or [Continue] for the exposure metering time. If [Continue] is selected, metering continues until the shutter release button is pressed fully or the camera is turned off.



4. AE-L with AF Locked

C1

Exposure is locked when focus is locked.

5. Link AE and AF Point

C1

The metering point and the AF point can be linked when the metering mode is set to  (Multi-segment), or when the focusing area selection mode is set to  (Select) and the metering mode is set to  (Spot). Exposure is adjusted in accordance with the position of the selected AF point.

6. Auto EV Compensation

C1

Compensates automatically when the proper exposure cannot be determined.

7. Bulb (B) Mode Options

C1

Sets the function of the shutter release button in **B** mode.

Type1	Continuous exposure while the shutter release button is pressed.
Type2	Press the shutter release button to start exposure, and press it again to end exposure.

Memo

- The camera operates in the same manner when shooting with a remote control unit.

8. Bracketing Order

C2

Sets the order for Exposure Bracketing shooting.

Setting	Frames	Order
0 - +	2 frames	0 → -1, 0 → +1
	3 frames	0 → -1 → +1
	5 frames	0 → -1 → +1 → -2 → +2
- 0 +	2 frames	-1 → 0, 0 → +1
	3 frames	-1 → 0 → +1
	5 frames	-2 → -1 → 0 → +1 → +2
+ 0 -	2 frames	0 → -1, +1 → 0
	3 frames	+1 → 0 → -1
	5 frames	+2 → +1 → 0 → -1 → -2
0 + -	2 frames	-1 → 0, +1 → 0
	3 frames	0 → +1 → -1
	5 frames	0 → +1 → -1 → +2 → -2

9. One-Push Bracketing

C2

Shoots all frames with one press of the shutter release button when using Exposure Bracketing.

10. WB Adjustable Range

C2

Fine-tunes the white balance when the light source is specified.

Fixed	Color temperature of the light source is fixed.
Auto Adjustment	Automatically performs fine-tuning.

11. WB When Using Flash

C2

Select [Auto White Balance], [Multi Auto White Balance], [Flash] or [Unchanged] for the white balance when the flash discharges.

12. AWB in Tungsten Light

C2

Adjusts the tungsten light color tone when [White Balance] is set to [Auto White Balance].

Subtle Correction	Keeps the tungsten light color tone.
Strong Correction	Applies a stronger correction of the tungsten light.

13. Color Temperature Steps

C2

Sets the unit of the white balance color temperature to [Kelvin] or [Mired].

14. Superimpose AF Area

C2

The selected AF point lights red in the viewfinder.

15. AF.S Setting

C3

Selects the action priority for when the focus mode is set to **AF.S** and the shutter release button is fully pressed.

Focus-priority	The shutter is not released until the subject is in focus.
Release-priority	The shutter is released even if the subject is not in focus.

16. 1st Frame Action in AF.C

C3

Selects the 1st frame action priority for when the focus mode is set to **AF.C** and the shutter release button is fully pressed.

Release-priority	Starts shooting immediately, even if the subject is not in focus.
Auto	Determines whether focus adjustment is necessary depending on the focusing conditions.
Focus-priority	Starts shooting when the subject is in focus.

17. Action in AF.C Continuous

C3

Selects the action priority during Continuous Shooting for when the focus mode is set to **AF.C**.

Focus-priority	Prioritizes tracking the subject.
Auto	Determines which to prioritize, focus or framerate.
FPS-priority	Prioritizes the speed of Continuous Shooting.

18. Hold AF Status

C3

Sets whether to maintain the focus for a certain amount of time when the subject happens to move out of the selected focusing area after being focused. Selects [Off], [Low], [Medium], or [High].

19. AF with Remote Control

C3

Enables autofocus with remote control.

20. Color Space

C3

Sets the color space of image files to [sRGB] or [AdobeRGB].



Memo

- Image file names vary depending on the color space setting. (p.R32)

Color Space	File Name
sRGB	IMGpxxxx.JPG
AdobeRGB	_IMGxxxx.JPG

21. LCD Panel Illumination

C3

Sets the LCD panel backlight setting to [Low] or [High].

22. Save Rotation Info

C4

Saves the rotation information of an image according to the orientation of the camera when the image was shot.

23. Save Menu Location

C4

The last menu tab displayed on the monitor is saved, and it is displayed again the next time **MENU** is pressed.

24. AF Fine Adjustment

C4

Adjusts the AF focus position.

- 1 Select [24. AF Fine Adjustment] in C4 menu and press **▶**.

The [24. AF Fine Adjustment] screen appears.

- 2 Select [Apply All] or [Apply One] and press **OK**.

Apply All	Applies the same adjustment value to all lenses.
Apply One	Saves an adjustment value for the lens being used. (Up to 20 values)

- 3 Select [Setting] and adjust the value.

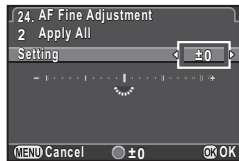

Available operations

▶ /	to the right	Adjusts the focus to a closer position.
◀ /	to the left	Adjusts the focus to a farther position.
○		Resets the adjustment value to the default setting.

- 4 Press **OK**.

The adjustment value is saved.

- 5 Press **MENU** twice.

The camera returns to standby mode.

Memo

- Check focus accuracy by magnifying the image during Live View (p.39) or Digital Preview (p.67).

25. Flash Sync Speed

C4

Selects the flash sync speed.

1/125	1/125 seconds
1/100 (1/90)	1/100 seconds at 1/3 EV Steps, 1/90 seconds at 1/2 EV Steps
1/80 (1/90)	1/80 seconds at 1/3 EV Steps, 1/90 seconds at 1/2 EV Steps
1/60	1/60 seconds

26. 4-way Controller Options

C4

Selects the operation of the arrow keys (▲▼◀▶) for when the focusing area selection mode is set to one of the following “Select” modes: , , , and .

Type1	Switches the operation of ▲▼◀▶ to that for the Change AF Point mode or the direct key mode by pressing .
Type2	Switches the operation of ▲▼◀▶ to that for the direct key mode only when is pressed. While the focusing area selection mode is set to one of the “Select” type modes, the AF point can be changed using ▲▼◀▶.

Caution

- When [Type2] is set, regardless of the focusing area selection mode, the direct key operation for making settings such as those for Drive Mode are not available until is pressed.

27. Mirror Up Operation

C4

Set to [Off] to disable the Mirror Up dial operation.

28. Shake Reduction Options

C4

Select whether to activate Shake Reduction at the moment of capture only (Type1) or while pressing the shutter release button halfway (Type2).

Memo

- The Shake Reduction function is available when a lens with the SR system is used in mode. In mode, Shake Reduction can be activated from [Movie SR] of the 1 menu. (p.R25)

29. Enable/Disable Controls

C5

Select the group of buttons and dials of which operation is temporarily disabled.

Type1	ISO AE-L AREA
Type2	ISO AE-L AREA AF RAW

Turning to the right while pressing **Lock** disables the operation of the selected group of buttons and dials. Turning to the left while pressing **Lock** enables the operation of them. is displayed on the status screen, LCD panel, Live View screen and in the viewfinder when the operation of the control interfaces is disabled.

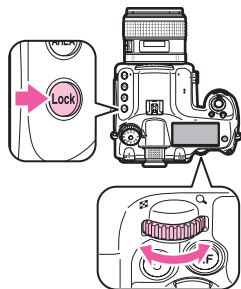

Reset Custom Functions

Resets all the settings of the Custom Setting menu to the defaults.

Memo

- The adjustment value of [24. AF Fine Adjustment] is not reset.

Appendix

Restrictions on the Combinations of Special Functions

×: Not available

		B Mode	HDR Capture	Exposure Bracketing	Mirror Lock-up Shooting	Lens Correction	Save RAW Data
Live View							
Drive Mode	Continuous Shooting	×	×				×
	Multi-exposure		×	×		×	
	Interval Shooting	×		×	×		×
	Interval Composite	×	×	×	×	×	×
Exposure Bracketing		×					
Flash			×				

Main Specifications

Model Description

Type	TTL autofocus, auto-exposure medium format digital SLR camera
Lens Mount	PENTAX 645AF2 mount with AF coupler, lens information contacts, and power contacts
Usable Lens	PENTAX 645AF2, 645AF and 645A mount lenses

Image Capture Unit

Image Sensor	Type: CMOS with a primary color filter Size: 43.8 × 32.8 (mm)
Effective Pixels	Approx. 51.4 megapixels
Total Pixels	Approx. 52.99 megapixels
Dust Removal	Image sensor cleaning using ultrasonic vibrations "DR II" with the Dust Alert function
Sensitivity (Standard output)	ISO AUTO/100 to 204800 (EV steps can be set to 1EV, 1/2 EV, or 1/3 EV)
Image Stabilizer	Lens-shift type (when a lens with SR system is used)

File Formats

Recording Formats	RAW (PEF/DNG), TIFF, JPEG (Exif 2.30), DCF 2.0 compliant
Recorded Pixels	JPEG: (51M: 8256×6192), (36M: 6912×5184), (21M: 5376×4032), (3M: 1920×1440) RAW: (51M: 8256×6192) TIFF: (51M: 8256×6192)
Quality Level	RAW (14bit): PEF, DNG JPEG: ★★★ (Best), ★★ (Better), ★ (Good), RAW + JPEG simultaneous recording available
Color Space	sRGB, AdobeRGB
Storage Media	SD, SDHC*, SDXC* memory card, Eye-Fi card, FLUCARD *UHS-I compatible
Dual Card Slot	Sequential Use, Save to Both, Separate RAW/JPEG, Copying images between slots possible

Storage Folder	Folder Name: Date (100_1018, 101_1019...) or a user-assigned name (default: PENTX)
Storage File	File Name: a user-assigned name (default: IMG*****) File No.: Sequential Numbering, Reset

Viewfinder

Type	Keplerian telescopic trapezoid prism finder
Coverage (FOV)	Approx. 98%
Magnification	Approx. 0.62× (55mm F2.8 at infinity), Approx. 0.85× (75mm F2.8 at infinity)
Eye-Relief Length	Approx. 21 mm (from the view window), Approx. 24.1 mm (from the center of lens)
Diopter Adjustment	Approx. -3.5 m to + 2.0 m ⁻¹
Focusing Screen	Interchangeable Natural-Bright-Matte focusing screen

Live View

Type	TTL method using CMOS image sensor
Focus Method	Contrast detection AF (Face Detection, Tracking, Multiple AF Points, Select, Spot) Focus Peaking: ON/OFF
Display	Field of view: approx. 100%, Magnified view (2×, 4×, 8×, 12×, 16×), Grid Display (Grid Style: 4×4 Grid, Golden Section, Scale, Square 1, Square 2, Grid Color: translucent black, translucent white), Histogram, Highlight Alert, Rotate Display 180°

LCD Monitor

Type	Tiltable TFT color LCD monitor featuring an air-gapless structure with an AR-coated, tempered-glass front panel
Size	3.2 inches
Dots	Approx. 1037K dots
Adjustment	Brightness, Saturation and Color adjustable

White Balance

Type	Method using a combination of the CMOS image sensor and the light source detection sensor
White Balance	Auto White Balance, Multi Auto White Balance, Daylight, Shade, Cloudy, Fluorescent Light (D : Daylight Color, N : Daylight White, W : Cool White, L : Warm White), Tungsten Light, Flash, CTE , Manual White Balance (up to 3 settings can be saved), Color Temperature (up to 3 settings can be saved), Copying the white balance settings of a captured image possible
Fine Adjustment	Adjustable ± 7 steps on A-B axis and G-M axis

Autofocus System

Type	TTL: phase-matching autofocus
Focus System	SAFOX 11, 27 AF points (25 cross-type focus points in the center)
Brightness Range	EV -3 to 18 (ISO100, at normal temperature)
AF Modes	Single AF (A.F.S), Continuous AF (A.F.C), Focus operation customizable
Focusing Area Selection Modes	Spot, Select, Expanded Area AF (S, M, L), Zone Select, Auto (27 AF Points)

Exposure Control

Type	TTL open aperture metering using 86K pixel RGB sensor Metering Modes: Multi-segment metering, Center-weighted metering, Spot metering
Metering Range	EV -1 to 21 (ISO100 at 55mm F2.8)
Exposure Modes	Program, Sensitivity Priority, Shutter Priority, Aperture Priority, Shutter & Aperture Priority, Manual, Bulb, Flash X-sync Speed, USER1, USER2, USER3
EV Compensation	± 5 EV (1/3 EV steps or 1/2 EV steps can be selected)
AE Lock	Button type (timer-control: two times the meter operating time set in Custom Setting), Continuous as long as the shutter release button is halfway pressed

Exposure Bracketing	2, 3 or 5 frames, Available with Continuous Shooting, Self-timer or Remote Control of the drive modes
---------------------	---

Shutter

Type	Electronically controlled vertical-run focal plane shutter
Shutter Speed	Auto: 1/4000 to 30 sec., Manual: 1/4000 to 30 sec. (1/3 EV steps or 1/2 EV steps), Bulb

Drive Modes

Mode Selection	Stills: Single Frame, Continuous (H, L), Self-timer (12 sec., 2 sec.), Remote Control (immediately, 3 sec., continuous), Multi-exposure (available with Continuous, Self-timer or Remote Control), Interval Shooting, Interval Composite Movie: Remote Control, Interval Movie Record
Mirror Lock-up Shooting	Available with Continuous, Self-timer, Remote Control or Multi-exposure
Continuous Shooting	Max. approx. 3 fps, JPEG (\square): ★★★ at Continuous H): up to approx. 30 frames, RAW: up to approx. 10 frames, TIFF: up to approx. 12 frames Max. approx. 1 fps, JPEG (\square): ★★★ at Continuous L): up to approx. 300 frames, RAW: up to approx. 25 frames, TIFF: up to approx. 15 frames *When the sensitivity is set to ISO100.
Multi-Exposure	Composite Mode: Additive, Average, Bright Number of Shots: 2 to 2000 images
Interval Shooting	Stills: Interval: 2 sec. to 24 hr., Number of shots: 2 to 2000 images, Start Interval: Now, Set Time Movie: Recorded Pixels: \square 4K/ \square FullHD/ \square HD, Interval: 2 sec. to 1 hr., Recording time: 14 sec. to 99 hr., Start Interval: Now, Set Time



Flash

Flash Modes	Flash On, Flash On+Red-eye Reduction, Slow-speed Sync, Slow-speed Sync+Red-eye, P-TTL, Trailing Curtain Sync, contrast-control-sync, high-speed sync, wireless sync (available with a dedicated external flash)
Sync Speed	1/125 sec.
Flash Exposure Compensation	-2.0 to +1.0 EV

Capture Settings

Custom Image	Bright, Natural, Portrait, Landscape, Vibrant, Radiant, Muted, Bleach Bypass, Reversal Film, Monochrome, Cross Processing
Cross Processing	Random, Preset 1-3, Favorite 1-3
Noise Reduction	Slow Shutter Speed NR, High-ISO NR
Dynamic Range Settings	Highlight Correction, Shadow Correction
Lens Correction	Distortion Correction, Lateral Chromatic Aberration Correction, Peripheral Illumination Correction, Diffraction Correction
HDR Capture	Auto, Type1, Type2, Type3, Exposure Bracket Value adjustable, Auto Align (automatic composition correction function) available
Electronic Level	Displayed in viewfinder and LCD panel (horizontal direction only); displayed on LCD monitor (horizontal direction and vertical direction)

Movie

Recording Formats	MPEG-4 AVC/H.264 (MOV) *Motion JPEG (AVI) for Interval Movie Record
Recorded Pixels	 (1920×1080, 60i/50i/30p/25p/24p),  (1280×720, 60p/50p/30p/25p/24p)
Sound	Built-in stereo microphones, external microphone (stereo recording compatible), Recording Sound Level adjustable





























































































Recording Time	Up to 25 minutes; automatically stops recording if the internal temperature of the camera becomes high.
Custom Image	Bright, Natural, Portrait, Landscape, Vibrant, Radiant, Muted, Bleach Bypass, Reversal Film, Monochrome, Cross Processing
Cross Processing	Random, Preset 1-3, Favorite 1-3
HDR Capture *Available only for Interval Movie Record	Auto, Type1, Type2, Type3, Exposure Bracket Value adjustable

Playback Functions

Playback View	Single image display, Multi-image display (6, 12, 20, 35, 80 thumbnails), Image magnification (up to 16×, 1× display and quick zoom available), Grid Display (Grid Style: 4×4 Grid, Golden Section, Scale, Square 1, Square 2, Grid Color: translucent black, translucent white), Rotated image display, Histogram (Y histogram, RGB histogram), Highlight Alert, Auto Image Rotation, Detailed Information Display, Copyright Information (Photographer, Copyright Holder), Folder Display, Calendar Filmstrip Display, Slideshow, GPS information (latitude, longitude, altitude, Coordinated Universal Time (UTC))
Delete	Single image, all images, select & delete, folder, Instant Review image
Digital Filter	Base Parameter Adj, Extract Color, Toy Camera, Retro, High Contrast, Shading, Invert Color, Unicolor Bold, Bold Monochrome, Tone Expansion, Sketch, Water Color, Pastel, Posterization, Miniature, Soft, Starburst, Fish-eye, Slim
RAW Development	Development options: Select single image, Select multiple images, Select a folder Development parameters: File Format (JPEG/TIFF), Aspect Ratio, JPEG Recorded Pixels, JPEG Quality, Color Space, Distortion Correction, Lateral Chromatic Aberration Correction, Peripheral Illumination Correction, Diffraction Correction, Color Fringe Correction, White Balance, Custom Image, Digital Filter, HDR, Sensitivity, High-ISO NR, Shadow Correction

Editing Features	Color Moiré Correction, Resize, Cropping (aspect ratio can be changed and tilt adjustment is available), Movie Edit (dividing a movie file and deleting unwanted segments), Capturing a JPEG still picture from a movie, Saving RAW Data, Image Copy, Eye-Fi Image Transfer
------------------	---

Customization

USER Modes	Up to 3 settings can be saved
Custom Functions	29 items
Mode Memory	11 items
Button Customization/ E-Dial Programming	RAW Button: One Push File Format, Optical Preview, Digital Preview AF Button: Enable AF1, Enable AF2, Cancel AF Preview Dial: Optical Preview, Digital Preview  Button: LCD Panel Illumination, Modeling Flash, Test Flash E-dials (front/rear): customizable to each exposure mode
Enable/Disable Controls	Type1:             Type2:                                                                               
Text Size	Standard, Large
World Time	World Time settings for 75 cities (28 time zones)
Language	English, French, Germany, Spanish, Portuguese, Italian, Dutch, Danish, Swedish, Finnish, Polish, Czech, Hungarian, Turkish, Greek, Russian, Korean, Traditional Chinese, Simplified Chinese, Japanese
AF Fine Adjustment	±10 step, adjustment for all lenses or individual lenses (up to 20 can be saved)
Copyright Information	Names of "Photographer" and "Copyright Holder" are embedded to the image file. Revision history can be checked using the provided software.

Power Supply

Battery Type	Rechargeable Lithium-ion Battery D-LI90
AC Adapter	AC Adapter Kit K-AC132 (Optional)

Battery Life	Number of recordable images: approx. 650 images Playback time: approx. 400 minutes *Tested in compliance with CIPA standard using a fully-charged lithium-ion battery under the temperature of 23°C. Actual results may vary depending on the shooting conditions.
--------------	---

Interfaces

Connection Port	USB 3.0 (micro B), external power supply terminal, cable switch terminal, X-sync socket, HDMI output terminal (Type D), stereo microphone input terminal
USB Connection	MSC/PTP

Dimensions and Weight

Dimensions	Approx. 156 mm (W) × 117 mm (H) × 123 mm (D) (excluding protrusions)
Weight	Approx. 1550 g (including dedicated battery and an SD memory card) Approx. 1470 g (body only)

Accessories

Package Contents	Strap O-ST150, Large eyecup 645 O-EC107, Rechargeable Lithium-ion Battery D-LI90, Battery Charger D-BC90, AC plug cord, Software (CD-ROM) S-SW150 <Installed on the camera> Standard eyecup 645, Hot shoe cover Fk, Sync socket 2p cap, Body mount cap 645, triangular ring and protective cover
Software	Digital Camera Utility 5

Approximate Image Storage Capacity and Playback Time

(When using the fully charged battery)

Battery	Temperature	Normal Shooting	Playback Time
D-LI90	23°C	650	400 minutes

* The image storage capacity is based on measuring conditions in accordance with CIPA standards, while other data is based on our measuring conditions. Some deviation from the above figures may occur in actual use depending on the selected capture mode and shooting conditions.



Approximate Image Storage Capacity by Size

(When using a 16 GB memory card)

Recorded Pixels	JPEG Quality			RAW	TIFF
	★★★	★★	★		
L 51M	424	967	1915	143	98
M 36M	604	1372	2715	–	–
S 21M	996	2256	4412	–	–
XS 3M	7376	15443	27455	–	–

* The number of storable images may vary depending on the subject, shooting conditions, selected exposure mode and memory card, etc.

Symbols

 menu	R5, R15
 menu	R8, R24
 menu.....	R8, R26
 menu	R9, R28
C menu	R11, R39
 mode	51

Numerics

180° Rotation Info	R15
1st Frame Action in AF.C.....	R41
4-way Controller Options	R42

A

AC adapter.....	32, 94
Accessories	10, 28, 94
Action in AF.C Continuous.....	R41
AdobeRGB.....	R41
AE Lock	50
AE-L with AF Locked	R39
AF area	45, 46
AF Button.....	R20
AF Fine Adjustment	R42
AF frame.....	39
AF Mode	44
AF point	45
AF with Remote Control.....	R41
AF.C	44
AF.S	44

AF.S Setting	R40
Aperture Priority Automatic Exposure mode	48
Aspect Ratio.....	78, 82
Auto (AF Active Area)	45
Auto EV Compensation.....	R39
Auto Image Rotation	R26
AUTO ISO Parameters	R17
Auto Power Off.....	R34
Auto Resize	R35
Auto Screen Rotation	R30
Auto White Balance (White Balance).....	53
AV device.....	84
Av mode.....	48
AWB (White Balance).....	53
AWB in Tungsten Light	R40

B

B mode.....	48
Base Parameter Adj (Digital Filter)	79
Battery.....	30
Battery level	31
Bleach Bypass (Custom Image).....	68
Bold Monochrome (Digital Filter).....	79
Bracketing	62
Bracketing Order.....	R40
Bright (Custom Image).....	68
Brightness histogram	21
Bulb (B) Mode Options.....	R39

Bulb Exposure mode	48
Button	12
Button Customization	R20

C

C (AF Mode)	44
Cable switch	95
Cable switch terminal	11
Calendar Filmstrip Display.....	75
Card access lamp.....	11
Center-weighted metering	47
Changing the image size	77
Charging the battery.....	30
Charging time	30
City	R28
Cloudy (White Balance).....	53
Color Fringe Correction	82
Color Moiré Correction	78
Color Space.....	R41
Color Temperature (White Balance)	55
Color Temperature Steps	R40
Computer.....	87
Connecting to a computer	86
Continuous mode	44
Continuous Shooting	56
Contrast (Custom Image)	68
Contrast AF	R18
Contrast detection AF.....	44
Control panel	17, 41
Copyright Holder.....	R33

Copyright Information	R33
Create New Folder	R32
Cropping	78
Cross Processing (Custom Image)	69
CTE (White Balance)	53
Custom Image	68
Custom setting menu	R11, R39

D

Date Adjustment	35, R28
Daylight (White Balance)	53
Default settings	R5
Delete	73, R27
Delete all images	R27
Delete an image	73
Deleting a folder	75
Destination	R29
Detailed Information Display	20
Developing RAW images	82
Dial	12
Dial indicator	38
Diffraction Correction	R16
Digital Camera Utility 5	90, 91
Digital Filter	79
Digital Preview	67, R19
Diopter adjustment	37
Direct keys	41, R13
Display Color	R30
Display language	34, R28
Distortion Correction	R16

DNG	R15
D-Range Settings	R16
Drive Mode	56
DST (daylight saving time)	R29
Dust Alert	R36
Dust Removal	R37
Dynamic range	R16

E

E-Dial Programming	R20
Electronic Compass	18, R18
Electronic Level	18, 23, R19
Enable/Disable Controls	R43
Error messages	97
EV bar scale	22
EV Compensation	50
EV Steps	49, R39
Exif	R33
Expanded Area AF (AF Active Area)	45
Exposure Bracketing	62
Exposure metering timer	47, R39
Exposure Mode	48
Exposure Mode (USER mode)	R15, R23
Exposure Setting (Movie)	R24
Exposure warning	22
Extract Color (Digital Filter)	79
Eyecup	37
Eye-Fi card	33, R34
Eye-Fi Image Transfer	R34

F

Face Detection (Contrast AF)	46
File Format	R15
File Name	R32
File No.	R33
Filter Effect (Custom Image)	68
Firmware Info/Options	R38
Fish-eye (Digital Filter)	79
Flash	64, 94
Flash (White Balance)	53
Flash compatibility	66
Flash compensation	65
Flash Mode	65
Flash On	65
Flash Sync Speed	48, R42
Flicker Reduction	R34
Flucard	33, 96, R34
Fluorescent - Cool White (White Balance)	53
Fluorescent - Daylight Color (White Balance)	53
Fluorescent - Daylight White (White Balance)	53
Fluorescent - Warm White (White Balance)	53
Focus Method	44
Focus Peaking	R18
Folder display	75
Folder Name	R31
Format	36, R38

Framerate	R24	Image plane indicator	11	Lens Correction	R16
Function settings.....	40	Image Rotation.....	76	Link AE and AF Point	R39
G		Image storage capacity	R49	Live View	16, 39, R18
GPS	R18	Initial settings	34	Locking exposure value.....	50
GPS Time Sync	R18	Initializing a memory card	36, R38	LS lens.....	29
GPS unit	96	Installing software	88	M	
Green button.....	R20	Instant Review.....	38, R19	M mode.....	48
Grid Display	R19, R26	Interchangeable focusing screen	95	M.U.P.	63
Guide Display	38, R30	Interval Composite	60	Macintosh	86
H		Interval Movie Record	61	Manual Exposure mode.....	48
HDMI Out.....	R30	Interval Shooting	59	Manual White Balance.....	54
HDMI terminal.....	84	Invert Color (Digital Filter)	79	Memory.....	R22
HDR Capture	R16, R24	ISO AUTO Setting.....	R17	Memory card.....	33
Help	91	ISO sensitivity	47	Memory Card Options	R15, R24
High Contrast (Digital Filter)	79	J		Menu.....	42, R5
High/Low Key Adj		JPEG.....	R15	Menu operation.....	42, R14
(Custom Image)	68	K		Meter Operating Time.....	R39
High-ISO NR.....	R17	Kelvin	55, R40	Metering mode.....	47
Highlight Alert	R19, R26	L		Microphone.....	52
Highlight Correction	R16	Landscape (Custom Image).....	68	Miniature (Digital Filter)	79
Histogram Display.....	21, R19	Language/言語	34, R28	Mired.....	55, R40
Hold AF Status.....	R41	Language setting.....	34, R28	Mirror Up.....	63
Hometown.....	34, R29	Lat-Chromatic-Ab Adj.....	R16	Mirror Up Operation.....	R42
Hue (Custom Image)	68	LCD Display	R30	Mode dial	38, 49
I		LCD Display Settings	R30	Mode dial lock button.....	38
Illumination Button	R21	LCD Panel.....	23	Monitor.....	15
Image Capture Settings	R15	LCD Panel Illumination.....	R41	Monochrome (Custom Image).....	68
Image Copy	77	Lens	26	Motion JPEG	61
Image finishing tone.....	68	Lens compatibility.....	28	Movie Capture Settings	R24
				Movie Edit.....	81

Movie menu	R8, R24
Movie mode	51
Movie SR	R25
MSC	R30
Multi Auto White Balance (White Balance)	53
Multi-exposure	58
Multi-image display	74
Multiple AF Points (Contrast AF)	46
Multi-segment metering	47
Muted (Custom Image)	68
N	
Names of parts	11
Natural (Custom Image)	68
Noise Reduction	R17
O	
One Push File Format	R21
One-Push Bracketing	R40
Optical Preview	67
P	
P mode	48
Pastel (Digital Filter)	79
PEF	R15
Peripheral Illumination Correction	R16
Photographer	R33
Pixel Mapping	R35
Pixels	R15
Playback	39

Playback Info Display selection screen	19
Playback menu	R8, R26
Playback mode	39
Playback mode palette	72, R13
Portrait (Custom Image)	68
Posterization (Digital Filter)	79
Power	34
Power frequency	R34
Preview	67, R19
Preview Dial	67, R21
Program Automatic Exposure mode	48
Program Line	48, R18
Protect	83, R26
Protect All Images	R26
Provided software	88
PTP	R30
Q	
Quality Level	R15
Quick Zoom	R26
QuickTime	86
R	
Radiant (Custom Image)	68
RAW	R15
RAW/Fx Button	R20
Rec. Mode menu	R5, R15
Recordable time	51
Recorded Pixels	R15, R24

Recording Sound Level	R24
Red-eye Reduction	65
Remote Control	57, 96
Reset	R35, R43
Resize	77
Retro (Digital Filter)	79
Reversal Film (Custom Image)	68
RGB histogram	21
Rotate Display 180°	R19
Rotation	76
Rotation Direction (E-Dial Programming)	R20
S	
Saturation (Custom Image)	68
Save as Manual WB	54
Save Menu Location	42, R41
Save RAW Data	38, 39, 40, R19
Save Rotation Info	R41
Save Settings (White Balance)	54
Save USER Mode	R22
SD Memory Card	33
Select (AF Active Area)	45
Select (Contrast AF)	46
Select & Delete	74
Self-timer	57
Sensitivity	47, 82
Sensitivity Priority Automatic Exposure mode	48
Sensitivity Steps	R39
Sensor Cleaning	R37

Sequential Numbering	R33	Starburst (Digital Filter)	79	USB terminal	87
Set-up menu	R9, R28	Status Screen.....	16	U1/U2/U3 mode.....	48, R22
Shade (White Balance).....	53	Stereo microphone.....	11	User registration	91
Shading (Digital Filter)	79	Stills/Movie switching dial.....	38, 51	User setting mode	48, R22
Shadow Correction	R16	Strap.....	26	V	
Shake Reduction	63, R25, R43	Superimpose AF Area.....	22, R40	Vertical position	18
Shake Reduction Options.....	R43	Sv mode.....	48	Vibrant (Custom Image)	68
Sharpness (Custom Image).....	68	Switch.....	12	Viewfinder.....	22
Shooting.....	38	Switching between		Volume	R24, R29
Shooting Info Display.....	18	the memory cards.....	39	Volume label.....	37
Shooting information.....	15	Sync cord	64	W	
Shutter & Aperture Priority		Sync socket.....	64	WARRANTY POLICY.....	105, R55
Automatic Exposure mode.....	48	Sync socket 2P cap.....	64	Water Color (Digital Filter).....	79
Shutter Priority Automatic		System requirements	86	WB Adjustable Range	R40
Exposure mode.....	48	T		WB When Using Flash	R40
Single image display.....	19, 39, 73	TAv mode	48	White Balance	53
Single mode.....	44	Testing your camera	38	Wi-Fi transmission.....	R34
Sketch (Digital Filter)	79	Text Size	35, R29	Windows	86
Slideshow	76, R26	TIFF.....	82, R15	Wireless LAN.....	R34
Slim (Digital Filter)	79	Time Setting	R29	Wireless Memory Card.....	R34
Slow Shutter Speed NR.....	R17	Tone Expansion (Digital Filter).....	79	World Time	R28
Slow-speed Sync.....	65	Toning (Custom Image)	68	X	
Soft (Digital Filter).....	79	Toy Camera (Digital Filter).....	79	X mode.....	48
Sound	51	Tracking (Contrast AF).....	46	Z	
Sound Effects	R29	TTL phase-matching autofocus.....	44	Zone Select (AF Active Area).....	45
Speaker	11	Tungsten (White Balance).....	53	Zoom display	73
Specifications.....	R45	Tv mode.....	48		
Spot (AF Active Area).....	45, 46	U			
Spot metering	47	Unicolor Bold (Digital Filter)	79		
sRGB	R41	USB Connection.....	87, R30		
Standby mode.....	15				

WARRANTY POLICY

All our cameras purchased through authorized bona fide photographic distribution channels are guaranteed against defects of material or workmanship for a period of twelve months from the date of your purchase. Service will be rendered, and defective parts will be replaced without cost to you within that period, provided the camera does not show evidence of impact, sand or liquid damage, mishandling, tampering, battery or chemical corrosion, operation contrary to operating instructions, or modification by an unauthorized repair shop. The manufacturer or its authorized representatives shall not be liable for any repair or alterations except those made with its written consent and shall not be liable for damages from delay or loss of use or from other indirect or consequential damages of any kind, whether caused by defective material or workmanship or otherwise; and it is expressly agreed that the liability of the manufacturer or its representatives under all guarantees or warranties, whether expressed or implied, is strictly limited to the replacement of parts as hereinbefore provided. No refunds will be made on repairs by non-authorized service facilities.

Procedure During 12-month Warranty Period

Any camera which proves defective during the 12-month warranty period should be returned to the dealer from whom you purchased the camera or to the manufacturer. If there are no representatives of the manufacturer in your country, send the camera to the manufacturer, with postage prepaid. In this case, it will take a considerable length of time before the camera can be returned to you owing to the complicated customs procedures required. If the camera is covered by warranty, repairs will be made and parts replaced free of charge, and the camera will be returned to you upon completion of servicing. If the camera is not covered by warranty, regular charges of the manufacturer or of its representatives will apply. Shipping charges are to be borne by the owner. If your camera was purchased outside of the country where you wish to have it serviced during the warranty period, regular handling and servicing fees may be charged by the manufacturer's representatives in that country. Notwithstanding this, your camera returned to the manufacturer will be serviced free of charge according to this procedure and warranty policy. In any case, however, shipping charges and

customs clearance fees to be borne by the sender. To prove the date of your purchase when required, please keep the receipt or bills covering the purchase of your camera for at least a year. Before sending your camera for servicing, please make sure that you are sending it to the manufacturer's authorized representatives or their approved repair shops, unless you are sending it directly to the manufacturer. Always obtain a quotation for the service charge, and only after you accept the quoted service charge, instruct the service station to proceed with the servicing.

- **This warranty policy does not affect the customer's statutory rights.**
- **The local warranty policies available from our distributors in some countries can supersede this warranty policy. Therefore, we recommend that you review the warranty card supplied with your product at the time of purchase, or contact our distributor in your country for more information and to receive a copy of the warranty policy.**

For customers in USA
STATEMENT OF FCC COMPLIANCE

This device complies with Part 15 of the FCC Rules. Operation is subject to the following two conditions: (1) This device may not cause harmful interference, and (2) this device must accept any interference received, including interference that may cause undesired operation. Changes or modifications not approved by the party responsible for compliance could void the user's authority to operate the equipment. This equipment has been tested and found to comply with the limits for a Class B digital device, pursuant to part 15 of the FCC Rules.

These limits are designed to provide reasonable protection against harmful interference in a residential installation. This equipment generates, uses and can radiate radio frequency energy and, if not installed and used in accordance with the instructions, may cause harmful interference to radio communications. However, there is no guarantee that interference will not occur in a particular installation. If this equipment does cause harmful interference to radio or television reception, which can be determined by turning the equipment off and on, the user is encouraged to try to correct the interference by one or more of the following measures:

- Reorient or relocate the receiving antenna.
 - Increase the separation between the equipment and receiver.
 - Connect the equipment into an outlet on a circuit different from that to which the receiver is connected.
- * Consult the dealer or an experienced radio/TV technician for help.

For customers in Canada

This Class B digital apparatus complies with Canadian ICES-003.

Pour les utilisateurs au Canada

Cet appareil numérique de la classe B est conforme à la norme NMB-003 du Canada.

FOR CALIFORNIA, U.S.A. ONLY

Perchlorate Material-special handling may apply.
The lithium battery used in this camera contains perchlorate material, which may require special handling.
See www.dtsc.ca.gov/hazardouswaste/perchlorate

Declaration of Conformity
According to 47CFR, Parts 2 and 15 for
Class B Personal Computers and Peripherals

We: RICOH IMAGING AMERICAS CORPORATION

Located at: 633 17th Street, Suite 2600
Denver, Colorado 80202 U.S.A.
Phone: 800-877-0155
FAX: 303-790-1131

Declare under sole responsibility that the product identified herein complies with 47CFR Parts 2 and 15 of the FCC rules as a Class B digital device. Each product marketed is identical to the representative unit tested and found to be compliant with the standards. Records maintained continue to reflect the equipment being produced can be expected to be within the variation accepted, due to quantity production and testing on the statistical basis as required by 47CFR §2.909. Operation is subject to the following two conditions: (1) This device may not cause harmful interference, and (2) This device must accept any interference received, including interference that may cause undesired operation. The above named party is responsible for ensuring that the equipment complies with the standards of 47CFR §15.101 to §15.109.

Product Name: Lens-interchangeable medium-format digital SLR (Single Lens Reflex) Camera

Model Number: PENTAX 645Z

Contact person: Customer Service Manager

Date and Place: March, 2014, Colorado

Information for Users on Collection and Disposal of Old Equipment and Used Batteries



1. In the European Union

These symbols on the products, packaging and/or accompanying documents mean that used electrical and electronic equipment and batteries should not be mixed with general household waste.



Used electrical/electronic equipment and batteries must be treated separately and in accordance with legislation that requires proper treatment, recovery and recycling of these products.



By disposing of these products correctly you will help ensure that the waste undergoes the necessary treatment, recovery and recycling and thus prevent potential negative effects on the environment and human health which could otherwise arise due to inappropriate waste handling.

If a chemical symbol is added beneath the symbol shown above, in accordance with the Battery Directive, this indicates that a heavy metal (Hg = Mercury, Cd = Cadmium, Pb = Lead) is present in the battery at a concentration above an applicable threshold specified in the Battery Directive.

For more information about collection and recycling of used products, please contact your local authorities, your waste disposal service or the point of sale where you purchased the products.

2. In other countries outside the EU

These symbols are only valid in the European Union. If you wish to discard used products, please contact your local authorities or dealer and ask for the correct method of disposal.

For Switzerland: Used electrical/electronic equipment can be returned free of charge to the dealer, even when you don't purchase a new product. Further collection facilities are listed on the home page of www.swico.ch or www.sens.ch.



The CE Mark is a Directive conformity mark of the European Union.

**RICOH IMAGING
COMPANY, LTD.**

2-35-7, Maeno-cho, Itabashi-ku,
Tokyo 174-8639, JAPAN
(<http://www.ricoh-imaging.co.jp>)

**RICOH IMAGING
EUROPE S.A.S**

112 Quai de Bezons, B.P. 204,
95106 Argenteuil Cedex, FRANCE
(<http://www.ricoh-imaging.fr>)

**RICOH IMAGING
DEUTSCHLAND GmbH**

Am Kaiserkai 1, 20457 Hamburg, GERMANY
(<http://www.ricoh-imaging.de>)

**RICOH IMAGING
UK LTD.**

PENTAX House, Heron Drive, Langley, Slough,
Berks SL3 8PN, U.K.
(<http://www.ricoh-imaging.co.uk>)

**RICOH IMAGING
AMERICAS CORPORATION**

633 17th Street, Suite 2600,
Denver, Colorado 80202, U.S.A.
(<http://www.us.ricoh-imaging.com>)

**RICOH IMAGING
CANADA INC.**

1770 Argentia Road Mississauga,
Ontario L5N 3S7, CANADA
(<http://www.ricoh-imaging.ca>)

**RICOH IMAGING
CHINA CO., LTD.**

23D, Jun Yao International Plaza, 789 Zhaojiabang Road,
Xu Hui District, Shanghai, 200032, CHINA
(<http://www.ricoh-imaging.com.cn>)

- Specifications and external dimensions are subject to change without notice.