

Optimo 33L

FR

NL

DE

EN

ES

IT

PT

RU

KK

UK



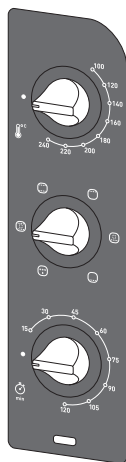
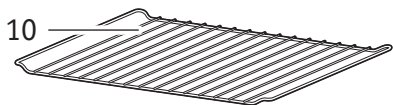
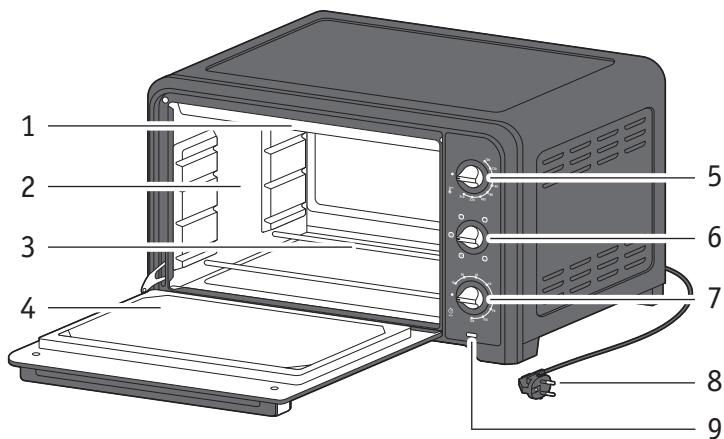

* selon modèle - afhankelijk van het model - je nach Modell - depending on the model - según el modelo - in base al modello -
 consoante o modelo - В зависимости от модели - үлгіге байланысты - залежно від моделі

DESCRIPTION

- 1 Résistance supérieure
- 2 Parois aluminium
- 3 Résistance inférieure
- 4 Porte double parois
- 5 Bouton de réglage température
- 6 Bouton des fonctions
- 7 Bouton de minuterie
- 8 Cordon d'alimentation
- 9 Voyant de fonctionnement
- 10 Grille réversible
- 11 Plat lèche-frite*

BESCHRIJVING

- 1 Bovenste verwarmingselement
- 2 Aluminium wanden
- 3 Onderste verwarmingselement
- 4 Dubbelwandige deur
- 5 Regelbare thermostaatknop
- 6 Functieknop
- 7 Timerknop
- 8 Snoer
- 9 Aan/uit-controlelampje
- 10 Omkeerbaar grillrooster
- 11 Ovenschaal*

BESCHREIBUNG

- 1 Oberes Heizelement
- 2 Aluminiumwände
- 3 Unteres Heizelement
- 4 Doppelwandige Tür
- 5 Temperaturregler
- 6 Funktionsknopf
- 7 Timer-Knopf
- 8 Netzkabel
- 9 Betriebskontrollleuchte
- 10 Umkehrbarer Grillrost
- 11 Backblech*

DESCRIPTION

- 1 Top heating element
- 2 Aluminium walls
- 3 Bottom heating element
- 4 Double-wall door
- 5 Temperature control button
- 6 Functions button
- 7 Timer button
- 8 Power cord
- 9 Power indicator light
- 10 Reversible grill rack
- 11 Food tray*

DESCRIPCIÓN

- 1 Resistencia superior
- 2 Paredes aluminio
- 3 Resistencia inferior
- 4 Puerta de doble cristal
- 5 Botón de ajuste de temperatura
- 6 Botón de funciones
- 7 Botón de temporizador
- 8 Cable de alimentación
- 9 Indicador de funcionamiento
- 10 Parrilla de grill reversible
- 11 Bandeja de comida*

* selon modèle - afhankelijk van het model - je nach Modell - depending on the model - según el modelo - in base al modello - consoante o modelo - В зависимости от модели - үлгіге байланысты - залежно від моделі

DESCRIZIONE

- | | | | |
|---|---|----|--------------------------------|
| 1 | Elemento riscaldante superiore | 7 | Pulsante timer |
| 2 | Pareti in alluminio | 8 | Cavo di alimentazione |
| 3 | Elemento riscaldante inferiore | 9 | Spia di alimentazione |
| 4 | Porta a doppia parete | 10 | Griglia di cottura reversibile |
| 5 | Pulsante di regolazione della temperatura | 11 | Vassoio degli alimenti* |
| 6 | Pulsante funzioni | | |

DESCRIÇÃO

- | | | | |
|---|----------------------------------|----|-----------------------------|
| 1 | Resistência superior | 7 | Botão temporizador |
| 2 | Paredes alumínio | 8 | Cabo de alimentação |
| 3 | Resistência inferior | 9 | Luz piloto de funcionamento |
| 4 | Porta de parede dupla | 10 | Grelha reversível |
| 5 | Botão deregulação da temperatura | 11 | Tabuleiro* |
| 6 | Botão das funções | | |

ОПИСАНИЕ

- | | | | |
|---|--------------------------------|----|---------------------------------|
| 1 | Верхний нагревательный элемент | 7 | Кнопка таймера |
| 2 | Алюминиевые стенки | 8 | Кабель питания |
| 3 | Нижний нагревательный элемент | 9 | Индикатор питания |
| 4 | Двухслойная дверца | 10 | Двухсторонняя решетка для гриля |
| 5 | Кнопка контроля температуры | 11 | Противень* |
| 6 | Кнопка выбора функций | | |

СИПАТТАМА

- | | | | |
|---|-------------------------------|----|-------------------------------|
| 1 | Жоғарғы қыздыру элементі | 7 | Таймер түймесі |
| 2 | Алюминий қабырғалар | 8 | Қуат сымы |
| 3 | Төменгі қыздыру элементі | 9 | Қуат индикаторының шамы |
| 4 | Қос қабырғалы есік | 10 | Аударуға болатын гриль сәресі |
| 5 | Температураны басқару түймесі | 11 | Тамақ науасы* |
| 6 | Функциялар түймесі | | |

ОПИС

- | | | | |
|---|--------------------------------|----|-------------------------------|
| 1 | Верхній нагрівальний елемент | 7 | Кнопка таймера |
| 2 | Алюмінієві стінки | 8 | Шнур живлення |
| 3 | Нижній нагрівальний елемент | 9 | Світловий індикатор живлення |
| 4 | Дверцята з подвійними стінками | 10 | Двостороння решітка для гриля |
| 5 | Кнопка регулювання температури | 11 | Піднос* |
| 6 | Кнопка вибору функцій | | |

* selon modèle - afhankelijk van het model - je nach Modell - depending on the model - según el modelo - in base al modello - consoante o modelo - В зависимости от модели - үлгіге байланысты - залежно від моделі

1

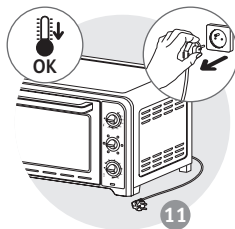
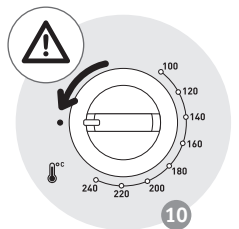
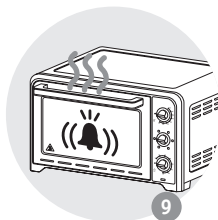
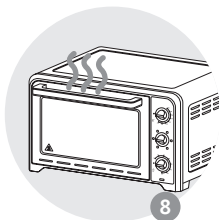
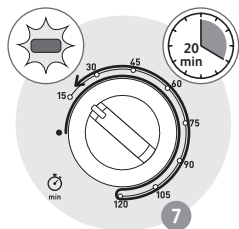
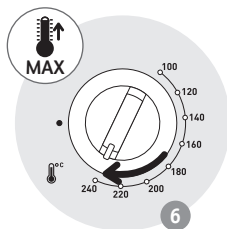
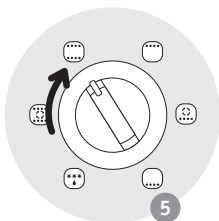
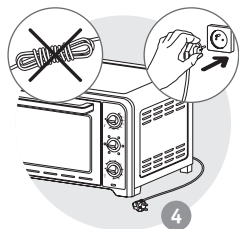
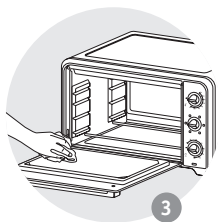
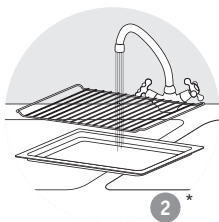
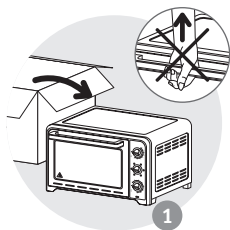

* selon modèle
afhankelijk van het model
je nach Modell
depending on the model
según el modelo
in base al modelo
consoante o modelo
В зависимости от модели
үлгіге байланысты
залежно від моделі

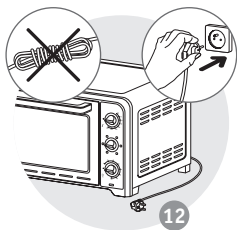

12

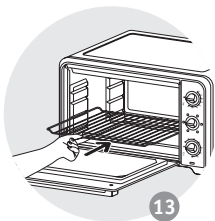

13

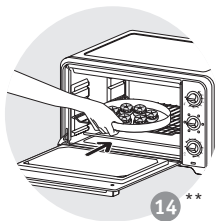

14 **

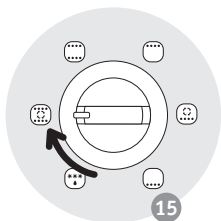

15

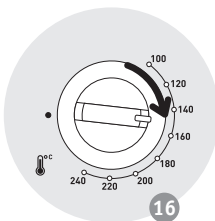

16

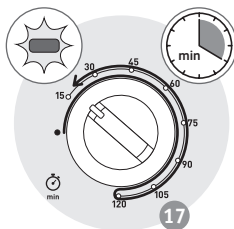

17

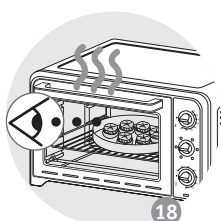

18

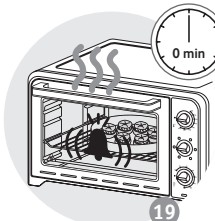

19

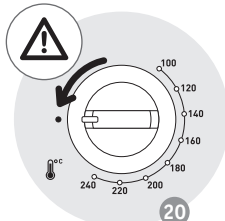

20

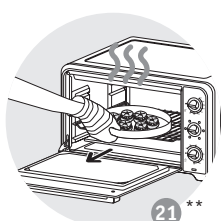

21 **

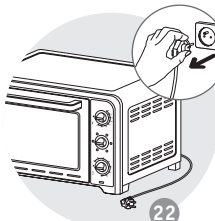

22

** Plat non fourni avec l'appareil
 Schaaf niet bij het apparaat inbegrepen
 Platte nicht im Lieferumfang inbegriffen
 The dish is not supplied with the appliance
 El plato no es suministrado con el aparato
 Piatto non fornito con l'apparechio
 Travessa não fornecida com o aparelho
 Блюдо не входит в комплект
 Құрылғымен бірге тәрелке
 қамтамасыз етілмейді
 Блюдо не входит в комплект
 поставки прибора

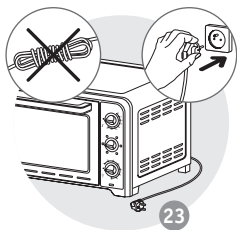

23

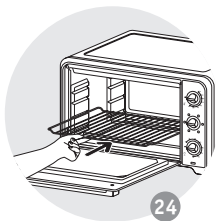

24

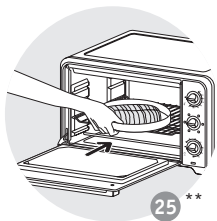

25 **

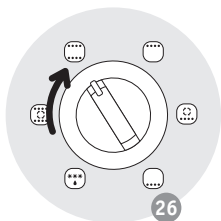

26

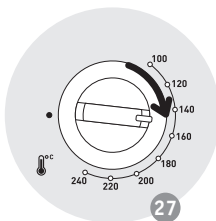

27

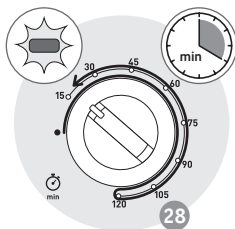

28

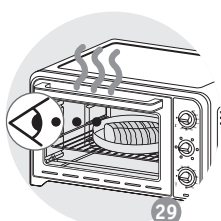

29

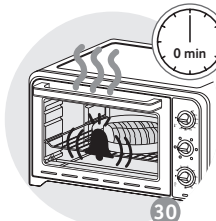

30

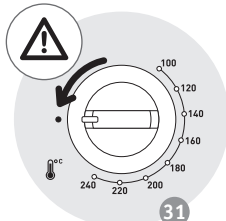

31

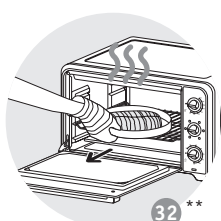

32 **

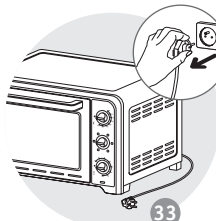

33

** Plat non fourni avec l'appareil
 Schaaf niet bij het apparaat inbegrepen
 Platte nicht im Lieferumfang inbegriffen
 The dish is not supplied with the appliance
 El plato no es suministrado con el aparato
 Piatto non fornito con l'apparecchio
 Travessa não fornecida com o aparelho
 Блюдо не входит в комплект
 Құрылғымен бірге тәрелке
 қамтамасыз етілмейді
 Блюдо не входит в комплект
 поставки приладу

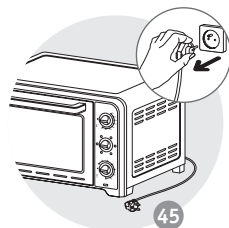
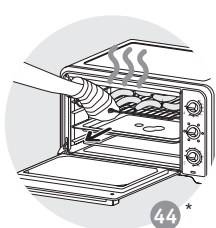
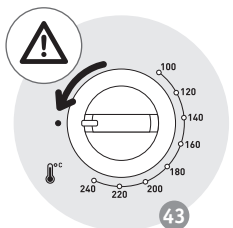
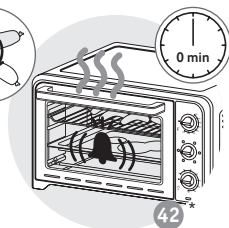
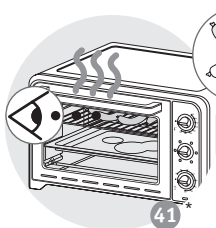
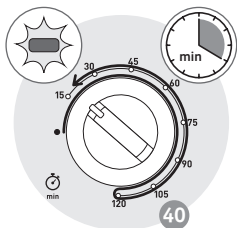
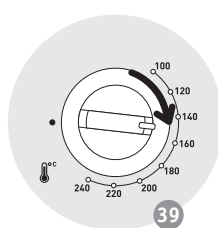
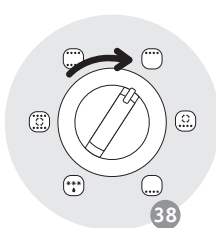
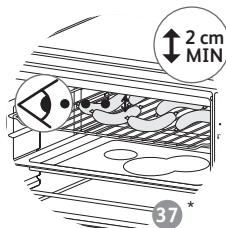
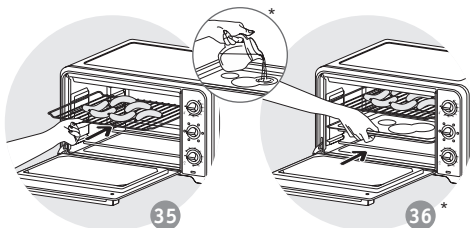
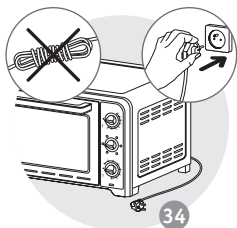

* selon modèle - afhankelijk van het model - je nach Modell - depending on the model - según el modelo - in base al modello - consoante o modelo - В зависимости от модели - үлгіге байланысты - залежно від моделі

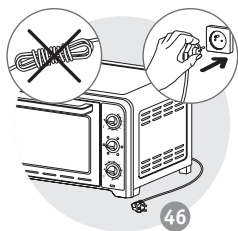

46

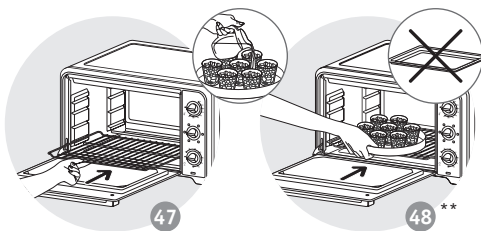

47

48 **

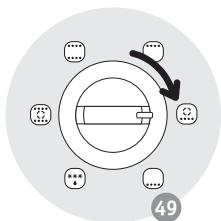

49

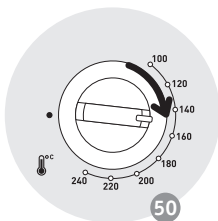

50

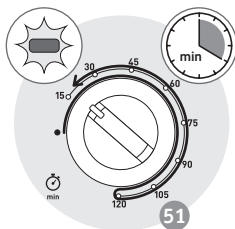

51

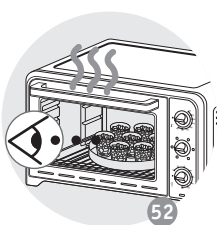

52

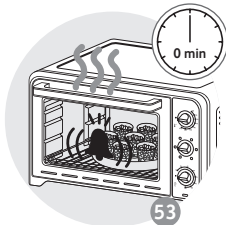

53

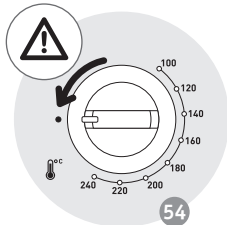

54

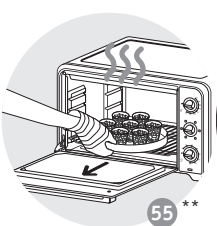

55 **

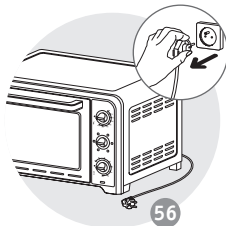

56

** Plat non fourni avec l'appareil
 Schaaf niet bij het apparaat inbegrepen
 Platte nicht im Lieferumfang inbegriffen
 The dish is not supplied with the appliance
 El plato no es suministrado con el aparato
 Piatto non fornito con l'apparecchio
 Travessa não fornecida com o aparelho
 Блюдо не входит в комплект
 Құрылғымен бірге тәрелке
 қамтамасыз етілмейді
 Блюдо не входит в комплект
 поставки приладу

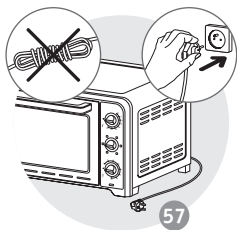

57

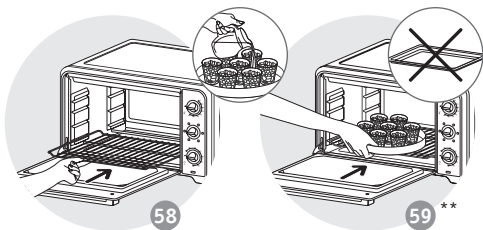

58

59 **

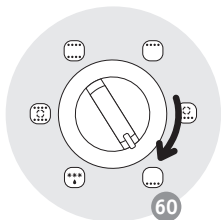

60

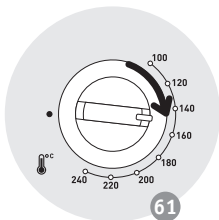

61

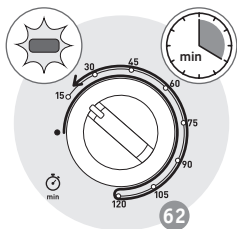

62

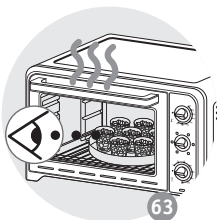

63

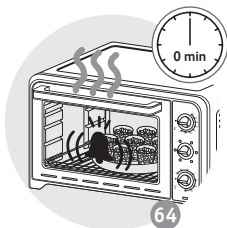

64

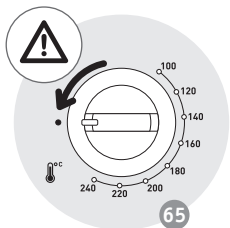

65

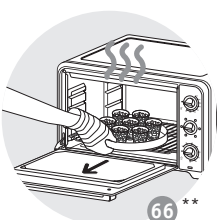

66 **

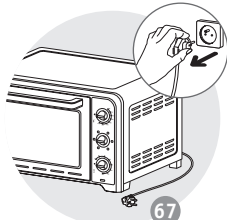

67

** Plat non fourni avec l'appareil
 Schaaf niet bij het apparaat inbegrepen
 Platte nicht im Lieferumfang inbegriffen
 The dish is not supplied with the appliance
 El plato no es suministrado con el aparato
 Piatto non fornito con l'apparechio
 Travessa não fornecida com o aparelho
 Блюда не входят в комплект
 Құрылғымен бірге тәурелке
 қамтамасыз етілмейді
 Блюда не входят в комплект
 поставки прибора

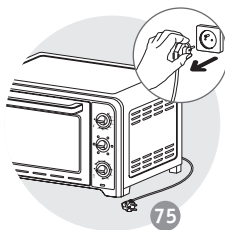
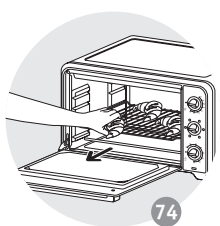
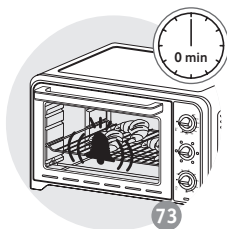
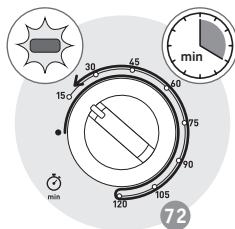
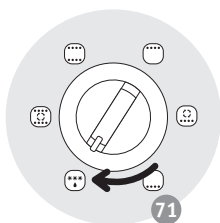
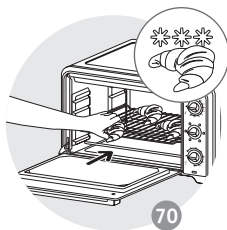
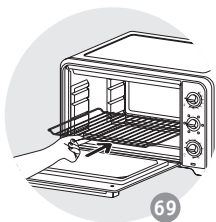
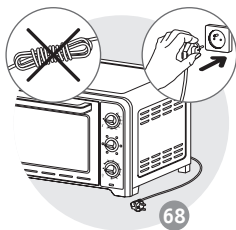

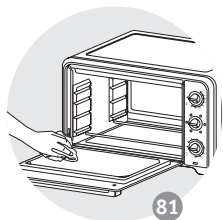
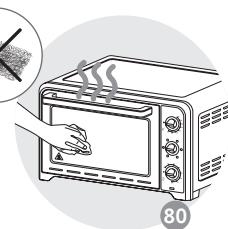
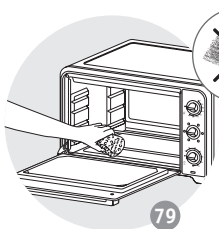
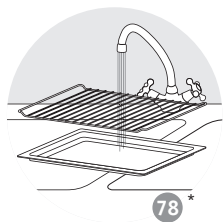
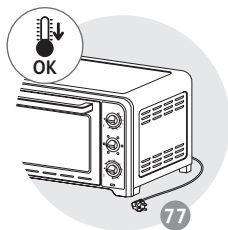
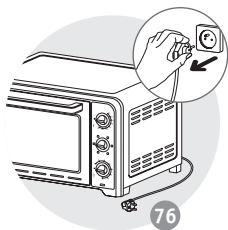

* selon modèle - afhankelijk van het model - je nach Modell - depending on the model - según el modelo - in base al modello -
 consoante o modelo - В зависимости от модели - улігіе байланысты - залежно від моделі



						min
	x4			10mins	240	18
	870g			10mins	230	56
	750g			10mins	240	40
	500g			-	240	57
	1000g			-	240	78
	x4			-	240	22
	x8			-	240	15
	350g			10mins	210	15
				10mins	240	40
	350g			10mins	240	15
				-	240	26
				10mins	200	42
				10mins	200	22
				10mins	200	35
	x6			10mins	150	10
	x6			10mins	200	18
				10mins	230	55
				10mins	240	25

